

# TRANSLATION OF THE ORIGINAL OPERATING INSTRUCTIONS

**IMPORTANT**

READ CAREFULLY BEFORE USE

KEEP SAFE TO CONSULT AT A LATER DATE



**BOSCH**



Twenty 4 E 24

21-26-3001

# Contents

1	About these operating instructions	6	3.1.5	Rechargeable battery	17
1.1	Manufacturer	6	3.1.5.1	Frame battery	18
1.2	Language	6	3.1.6	Display	19
1.3	Laws, standards and directives	6	3.1.7	Riding light	19
1.4	For your information	6	3.1.8	Charger	19
1.4.1	Warnings	6	3.2	Proper use	20
1.4.2	Markups	7	3.3	Improper use	21
1.5	Nameplate	8	3.3.1	Maximum permitted total weight	22
1.6	Type number and model	9	3.3.2	Data privacy information	22
1.7	Identifying the operating instructions	9	3.4	Technical data	23
2	Safety	10	3.4.1	Pedelec	23
2.1	Residual risks	10	3.4.2	Emissions	23
2.1.1	Risk of battery fire and explosion	10	3.4.3	Tightening torque	23
2.1.2	Risk of fire and explosion due to short circuit in the battery	10	3.4.4	Bicycle lighting	23
2.1.3	Fire hazard caused by overheated charger	10	3.4.5	Purion display	23
2.1.4	Electric shock caused by electric drive system	10	3.4.6	Motor Active Line Plus	23
2.1.5	Risk of a fall due to incorrectly set quick releases	11	3.4.7	PowerPack 400 battery	23
2.1.6	Risk of fire and burns due to hot motor	11	3.4.8	PowerPack 500 battery	24
2.1.7	Key breaking off	11	3.5	Description of controls and screens	25
2.2	Toxic substances	11	3.5.1	Handlebars	25
2.2.1	Brake fluid	11	3.5.2	Battery level indicator	25
2.2.2	Suspension oil	11	3.5.3	Display	25
2.2.3	Defective battery	11	3.5.3.1	Indicator unit km/h or mph	25
2.3	Requirements for the rider	11	3.5.3.2	Tachometer screen	25
2.4	Vulnerable groups	11	3.5.3.3	Information display	25
2.5	Personal protective equipment	11	3.5.4	System message	26
2.6	Safety markings and safety instructions	12	3.5.5	ABS indicator lamp	26
2.7	What to do in an emergency	12	3.6	Environmental requirements	27
2.7.1	Dangerous situation in road traffic	12	4	Transporting and storing	29
2.7.2	Leaked brake fluid	12	4.1	Physical transport characteristics	29
2.7.3	Battery vapours emitted	13	4.1.1	Designated handles/lifting points	29
2.7.4	Battery fire	13	4.2	Transporting	30
2.7.5	Leaked brake fluid	13	4.2.1	Using the brake transport securing system	30
2.7.6	Oil and lubricant leaks from the fork	13	4.2.2	Transporting the pedelec	30
2.7.7	Oil and lubricant leaks from the rear frame damper	13	4.2.3	Shipping a pedelec	30
3	Overview	14	4.2.4	Transporting the battery	30
3.1	Description	15	4.2.5	Shipping the battery	30
3.1.1	Wheel	15	4.3	Storing	31
3.1.1.1	Valve	15	4.3.1	Break in operation	31
3.1.2	Suspension	15	4.3.1.1	Preparing a break in operation	31
3.1.2.1	Suspension fork	15	4.3.1.2	Carrying out a break in operation	31
3.1.2.2	Steel suspension fork	16	5	Assembly	32
3.1.3	Brake system	16	5.1	Required tools	32
3.1.3.1	Disc brake	16	5.2	Unpacking	32
3.1.4	Electric drive system	17	5.2.1	Scope of delivery	32
			5.3	Preparing the battery	32
			5.3.1	Checking the battery	32
			5.4	Commissioning	33
			5.4.1	Installing the wheel in the Suntour fork	33

5.4.2	Checking the stem and handlebars	34	6.14.1	Using the riding light	54
5.4.2.1	Checking the connections	34	6.14.2	Selecting the level of assistance	54
5.4.2.2	Firm hold	34	6.14.3	Journey information	54
5.4.2.3	Checking the headset backlash	34	6.14.3.1	Switching the journey information	54
5.5	Pedelec sale	35	6.14.3.2	Resetting the trip distance	54
6	Operation	36	6.14.3.3	Resetting the range	55
6.1	Risks and hazards	36	6.14.3.4	Changing the tachometer unit	55
6.1.1	Personal protective equipment	37	6.14.3.5	Displaying versions and type numbers	55
6.2	Tips for a greater range	37	6.14.3.6	Set display screen brightness	55
6.3	Error message	39	6.14.4	Using the USB port	55
6.3.1	Display	39	6.14.5	Replacing the battery	55
6.3.2	Rechargeable battery	41	6.15	Brake	56
6.4	Instruction and customer service	42	6.15.1	Using the brake lever	57
6.5	Adjusting the pedelec	42	6.16	Suspension and damping	58
6.5.1	Adjusting the saddle	42	6.16.1	Adjusting the compression in the Suntour fork	58
6.5.1.1	Adjusting the saddle tilt	42	6.17	Gear shift	59
6.5.1.2	Determining the seat height	42	6.17.1	Using the derailleur gears	59
6.5.1.3	Adjusting the seat height with quick release	43	6.18	Parking the pedelec	60
6.5.1.4	Adjusting the seat position	43	7	Cleaning and servicing	61
6.5.2	Adjusting the handlebars	44	7.1	Cleaning after each ride	61
6.5.3	Adjusting the stem	44	7.1.1	Cleaning the suspension fork	61
6.5.3.1	Adjusting the height of the handlebars	44	7.1.2	Cleaning the rear frame damper	61
6.5.3.2	Adjusting the quick release clamping force	44	7.1.3	Cleaning the pedals	61
6.5.4	Retracting the brake linings	44	7.2	Basic cleaning	62
6.5.5	Adjusting the Suntour fork	45	7.2.1	Cleaning the frame	62
6.5.5.1	Adjusting the negative deflection	45	7.2.2	Cleaning the stem	62
6.5.5.2	Adjusting the steel suspension fork negative deflection	45	7.2.3	Cleaning the wheel	62
6.6	Accessories	46	7.2.4	Cleaning the drive elements	62
6.6.1	Child seat	46	7.2.5	Cleaning the rear frame damper	62
6.6.2	Trailer	47	7.2.6	Cleaning the chain	63
6.6.3	Pannier rack	47	7.2.7	Cleaning the battery	63
6.7	Check list before each ride	48	7.2.8	Cleaning the display	63
6.8	Using the kickstand	49	7.2.9	Cleaning the motor	63
6.8.1	Raising the kickstand	49	7.2.10	Cleaning the brake	64
6.9	Using the pannier rack	49	7.3	Servicing	64
6.10	Using the saddle	49	7.3.1	Servicing the frame	64
6.11	Rechargeable battery	50	7.3.2	Servicing the stem	64
6.11.1	Frame battery	50	7.3.3	Servicing the fork	64
6.11.1.1	Removing the frame battery	50	7.3.4	Servicing the drive elements	64
6.11.1.2	Inserting the frame battery	50	7.3.5	Servicing the pedals	64
6.11.2	Charging the battery	50	7.3.6	Servicing the chain	64
6.12	Electric drive system	52	7.4	Maintenance	65
6.12.1	Switching on the electric drive system	52	7.4.1	Wheel	65
6.12.2	Switching off the drive system	52	7.4.1.1	Checking the tyres	65
6.13	Display	53	7.4.1.2	Checking the rims	65
6.13.1	Overview of actions on the display screen	53	7.4.1.3	Checking and adjusting the tyre pressure – Dunlop valve	65
6.13.2	Switching on the display	53	7.4.1.4	Checking and adjusting the tyre pressure – Presta valve	66
6.13.3	Switching off the display	53	7.4.1.5	Checking and adjusting the tyre pressure – Schrader valve	66
6.14	Using the push assist system	54	7.4.2	Brake system	66

7.4.3	Checking the brake linings for wear	66	I.	Translation of the original EC/EU	
7.4.4	Checking the pressure point	66		Declaration of Conformity	98
7.4.5	Checking the brake discs for wear	66	II	Declaration of conformity for	
7.4.6	Checking the electrical cables and brake cables	67	14	incomplete machine	99
7.4.7	Checking the gear shift	67		Keyword index	102
7.4.8	Checking the stem	67			
7.4.9	Checking the USB port	67			
7.4.10	Checking the belt and chain tension	67			
8	Maintenance	68			
8.1	Suspension system	69			
8.1.1	Rear frame damper	69			
8.1.2	Suspension fork	70			
8.1.3	Suspension seat post	71			
8.2	Axle with quick release	71			
8.2.1	Checking the quick release	72			
8.3	Maintaining the stem	72			
8.4	Adjusting the gear shift	72			
8.4.1	Cable-operated gear shift, single-cable	73			
8.4.2	Cable-operated gear shift, dual-cable	73			
8.4.3	Cable-operated twist grip, dual-cable	73			
9	Troubleshooting, fault clearance and repair	74			
9.1	Troubleshooting and fault clearance	74			
9.1.1	The drive system or display do not start up	74			
9.1.2	Error message	74			
9.1.3	Assistance function errors	75			
9.1.4	Battery error	76			
9.1.5	Display errors	77			
9.1.6	Lighting does not work	77			
9.1.7	Other errors	77			
9.2	Repair	78			
9.2.1	Original parts and lubricants	78			
9.2.2	Replacing the lighting	78			
9.2.3	Adjusting the headlight	78			
9.2.4	Tyre clearance check	78			
10	Recycling and disposal	79			
11	Documents	80			
11.1	Parts list	80			
11.1.1	Twenty 4 E 24"	80			
11.2	Assembly report	81			
11.3	Maintenance instructions	83			
11.4	Charger operating instructions	87			
12	Glossary	95			
12.1	Abbreviations	97			
12.2	Simplified terms	97			
13	Appendix	98			



**Thank you for your trust!**

BULLS *pedelecs* are premium quality bicycles. You have made an excellent choice. Your specialist dealer will provide you with guidance and instruction and assemble your product. Your specialist dealer will also be happy to assist you in the future, whether you require maintenance, conversion or repair.

**Notice**

These *operating instructions* are not a substitute for personal instruction by the supplying specialist dealer.

These operating instructions are an integral part of the pedelec. Therefore, if it is re-sold at a later time, they must be handed over to the subsequent owner.

You are receiving these operating instructions with your new pedelec. Please take time to become familiar with your new pedelec. Use the tips and suggestions in the operating instructions. They will help you to enjoy your pedelec for a long time to come. We hope you have fun and wish you well on all of your rides!

The operating instructions are mainly designed for the rider or the operator. They aim to ensure that non-professionals can use the pedelec safely.

Sections are also designed especially for the specialist dealer. These sections aim to ensure that specialist dealers complete initial assembly and maintenance safely and reliably. The sections for specialist dealers are highlighted in grey and marked with a spanner symbol.



Download the operating instructions onto your phone at the following link, so that you can use them when you are out riding:

[www.bulls.de/service/downloads](http://www.bulls.de/service/downloads).

**Copyright**

© ZEG Zweirad-Einkaufs-Genossenschaft eG

Distribution or reproduction of these operating instructions and utilisation or communication of their content is prohibited unless expressly approved. Any infringement will render the offender liable for compensation. All rights reserved in the event that a patent, utility model or industrial design is registered.

**Editing**

Text and images:

ZEG Zweirad-Einkaufs-Genossenschaft eG  
Longericher Strasse 2  
50739 Köln, Germany

Translation:

RKT Übersetzungs- und Dokumentations-GmbH  
Markenstrasse 7  
40227 Düsseldorf, Germany

# 1 About these operating instructions

## 1.1 Manufacturer

The pedelec manufacturer is:

ZEG Zweirad-Einkaufs-Genossenschaft eG  
Longericher Strasse 2  
50739 Köln, Germany

Tel.: +49 221 17959 0  
Fax: +49 221 1795931  
E-mail: [info@zeg.de](mailto:info@zeg.de)  
Subject to internal changes

The information contained in these *operating instructions* are the approved technical specifications at the time of printing. Any significant changes are included in a new published version of the *operating instructions*. You will find any modifications to these *operating instructions* at:

[www.bulls.de/service/downloads](http://www.bulls.de/service/downloads).

## 1.2 Language

The *original operating instructions* are written in German. A translation is invalid without the *original operating instructions*.

## 1.3 Laws, standards and directives

The *operating instructions* comply with the essential requirements specified in:

- Machinery Directive 2006/42/EC
- Electromagnetic Compatibility Directive 2014/30/EU
- ISO 20607:2018 Safety of machinery – Instruction handbook – General drafting principles
- EN 15194:2018 Cycles – Electrically power assisted cycles – pedelec bicycles
- EN 11243:2016, Cycles – Luggage carriers for bicycles – Requirements and test methods
- ISO 17100:2016-05 Translation Services – Requirements for translation services.

## 1.4 For your information

Different markings are used in the operating instructions to make them easier to read.

### 1.4.1 Warnings

Warnings indicate hazardous situations and actions. You will find warnings in the *operating instructions*:



Will lead to serious or even fatal injuries if ignored. High-risk hazard.



May lead to serious or even fatal injuries if ignored. Medium-risk hazard.



May lead to minor or moderate injuries if ignored. Low-risk hazard.

**Notice**

May lead to material damage if ignored.

## 1.4.2 Markups



Instructions for specialist dealers are highlighted in grey. They are indicated by a screwdriver symbol. Information for specialist dealers does not require non-professionals to take any action.

You will find stylised forms of typeface in the *operating instructions*:

Stylised form	Use
<i>Italics</i>	Glossary term
<u>Underlined in blue</u>	Link
<u>Underlined in grey</u>	Cross references
✓ Check marks	Requirements
▶ Triangle	Instruction for action
1 Instruction for action	Several instructions for action in specified order
⇒	Result of the action
SPACED	Indicators on the display screen
•	Bulleted lists
<i>Only applies to pedelecs with this equipment</i>	Each type has a different kind of equipment. A note beneath the heading indicates components which can be used as an alternative.

Table 1: Markups

## 1.5 Nameplate

The nameplate is situated on the frame. You can see the exact position of the nameplate in Figure 2.

You will find thirteen pieces of information on the nameplate.

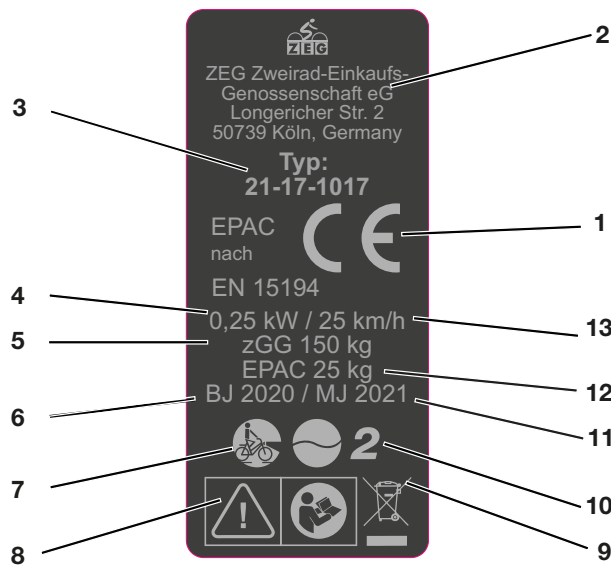

Figure 1: Example Nameplate

No.	Designation	Description
1	CE marking	The manufacturer uses the CE marking to declare that the pedelec complies with applicable requirements.
2	Manufacturer's contact details	You can contact the manufacturer at the address. You can find more information in Section 1.
3	Type number	All pedelec models have an eight-digit type number, which is used to specify the design model year, the type of pedelec and the version. You can find more information in Section 1.
4	Maximum continuous power	The maximum continuous power is the greatest possible power for the electric motor output shaft over 30 minutes.
5	Maximum permitted total weight	The maximum permitted total weight is the weight of the fully assembled pedelec with the rider and baggage.
6	Year of manufacture	The <i>year of manufacture</i> is the year in which the pedelec was manufactured. The production period is from August 2019 to July 2020.
7	Pedelec type	You can find more information in Section 3.2.
8	Safety markings	You can find more information in Section 1.4.
9	Disposal instructions	You can find more information in Section 10.
10	Area of use	You can find more information in Section 3.6.
11	Model year	The model year refers to the first production year that the series-manufactured pedelec was produced in the version concerned. The year of manufacture is different to the model year in some cases.
12	Weight of the ready-to-ride pedelec	The weight of the ready-to-ride pedelec is specified as a weight of 25 kg or above and refers to its weight at the time of purchase. You must add each additional accessory to the weight.
13	Shut-off speed	The speed that the pedelec reaches at the moment when the current has dropped to zero or to the no-load current value.

Table 2: Nameplate details

## 1.6 Type number and model

These operating instructions are an integral part of pedelecs with the type numbers:

Type no.	Model	Pedelec type
21-26-3001	Twenty 4 e 24"	Bicycle for young adults

Table 3: Type number, model and pedelec type

## 1.7 Identifying the operating instructions

The Identification number position is located on bottom left-hand side on each page. The identification number is composed of the document number, the version number and the release date.

<b>Identification number</b>	MY21B01 - 52_1.0_18.08.2020
------------------------------	-----------------------------

## 2 Safety

### 2.1 Residual risks

#### 2.1.1 Risk of battery fire and explosion

The safety electronics may fail if the batteries are damaged or faulty. The residual voltage can cause a short circuit. The battery may self-ignite and explode.

- ▶ Only use and charge the battery and accessories if they are in perfect condition.
- ▶ Never open or repair the battery.
- ▶ Batteries with external damage must be removed from service immediately.
- ▶ If a battery is dropped or struck, remove it from service and observe it for at least 24 hours.
- ▶ Faulty batteries are hazardous goods. Dispose of faulty batteries in the correct manner. Store battery in a dry place until disposal. Never store in the vicinity of flammable substances.

The battery is only protected from spray water. Penetration by water can cause a short circuit. The battery may self-ignite and explode.

- ▶ Never immerse the battery in water.
- ▶ Put battery out of service if you suspect water has penetrated it.

Temperatures over 60 °C can also cause liquid to leak from the battery and the battery will become damaged. The battery may self-ignite and explode.

- ▶ Protect the battery against heat.
- ▶ Never store next to hot objects.
- ▶ Never expose the battery to sustained direct sunlight.
- ▶ Avoid wide temperature fluctuations.

#### 2.1.2 Risk of fire and explosion due to short circuit in the battery

Metal objects may connect the battery's electrical terminals. The battery may self-ignite and explode.

- ▶ Never insert paper clips, screws, coins, keys and other small parts into the battery.

Chargers with excessive voltage damage batteries. This may result in fire or an explosion.

- ▶ Only use batteries approved for the pedelec.
- ▶ Clearly label the supplied charger.

#### 2.1.3 Fire hazard caused by overheated charger

The charger heats up when charging the battery. In case of insufficient cooling, this can result in fire or burns to the hands.

- ▶ Never use charger on a highly flammable surface.
- ▶ Never cover the charger during charging.
- ▶ Never leave the battery unattended during charging.

#### 2.1.4 Electric shock caused by electric drive system

Damaged chargers, cables and plug connectors increase the risk of electric shock.

- ▶ Check the charger, cable and plug connector before each use. Never use a damaged charger.

If water penetrates into the charger, there is a risk of electric shock.

- ▶ Never charge the battery outdoors.

### 2.1.5 Risk of a fall due to incorrectly set quick releases

Excessively high clamping force will damage the quick release and cause it to lose its function. Insufficient clamping force will result in unfavourable transmission of force. This can cause components to break. This will cause a crash with injuries.

- ▶ Never fasten a quick release using a tool (e.g. hammer or pliers).
- ▶ Only use the clamping lever with the specified set clamping force.

### 2.1.6 Risk of fire and burns due to hot motor

The motor housing becomes hot when riding. Touching it may cause burns to the skin or other objects.

- ▶ Never touch the motor housing directly after riding.
- ▶ Never place the pedelec on a flammable surface, such as grass or wood, directly after use.

### 2.1.7 Key breaking off

If you leave a key inserted when riding or transporting the pedelec, it may break off or the locking system may open accidentally.

- ▶ Remove the key to the battery lock.

## 2.2 Toxic substances

### 2.2.1 Brake fluid

Brake fluid may leak out after an accident or due to material fatigue. Brake fluid can be fatal if swallowed or inhaled.

- ▶ Never dismantle the brake system.
- ▶ Avoid contact with skin.
- ▶ Do not inhale vapours.

### 2.2.2 Suspension oil

Suspension oil in the fork and the rear frame damper is toxic to the touch, irritates respiratory tracts and causes cancer, sterility and mutation in germ cells.

- ▶ Never dismantle the rear frame damper or the suspension fork.
- ▶ Avoid contact with skin.

### 2.2.3 Defective battery

Liquids and vapours may leak from damaged or faulty batteries. Excessively high temperatures may also cause liquids and vapours to leak from the battery. Such liquids and vapours can irritate the airways and cause burns.

- ▶ Never dismantle the battery.
- ▶ Avoid contact with skin.
- ▶ Do not inhale vapours.

## 2.3 Requirements for the rider

The rider must demonstrate adequate physical, motor and mental abilities to ride on public roads. A minimum age of 14 years is recommended.

## 2.4 Vulnerable groups

Keep batteries and charger away from children and people with reduced physical, sensory or mental capabilities or lacking in experience and knowledge.

If minors use the pedelec, a legal guardian must should provide them with comprehensive instructions.

## 2.5 Personal protective equipment

Wear a suitable cycling helmet, sturdy footwear and typical close-fitting clothing to provide protection.

## 2.6 Safety markings and safety instructions

The nameplate contains these safety markings and safety instructions:



Symbol	Explanation
	General warning
	Adhere to the instructions for use

Table 4: Meaning of safety markings











Symbol	Explanation
	Read the instructions
	Separate collection of electrical and electronic devices
	Separate collection of ordinary and rechargeable batteries
	Must not be thrown into fire (burning prohibited)
	It is forbidden to open any batteries
	Device of protection class II
	Only suitable for use indoors
	Fuse (device fuse)
	EU conformity
	Recyclable material
	Protect from temperatures above 50 °C and direct sunlight

Table 5: Safety instructions

## 2.7 What to do in an emergency

### 2.7.1 Dangerous situation in road traffic

- ▶ In the event of any hazards or dangers in road traffic, apply the brakes on the pedelec until it comes to a halt. The brake acts as an emergency stop system in such cases.

### 2.7.2 Leaked brake fluid

- ▶ Remove those affected from the danger area to fresh air.
- ▶ Never leave those affected unattended.
- ▶ Immediately remove any clothing items contaminated with brake fluid.
- ▶ Never inhale vapours. Ensure sufficient ventilation.
- ▶ Wear gloves and safety gloves as protective equipment.
- ▶ Keep unprotected persons away.
- ▶ Take care with leaked brake fluid as it poses a slip hazard.
- ▶ Keep leaked brake fluid away from naked flames, hot surfaces and sources of ignition.
- ▶ Avoid contact with skin and eyes.

#### After inhalation

- ▶ Take in fresh air. Immediately consult a doctor in case of any discomfort.

#### After skin contact

- ▶ Wash affected skin with soap and water and rinse well. Remove contaminated clothing. Consult doctor in the event of pain or discomfort.

#### After contact with eyes

- ▶ Rinse eyes under flowing water for at least ten minutes with the lids open; also rinse under lids. Immediately consult a doctor in case of any pain or discomfort.



**After swallowing**

- ▶ Rinse out mouth with water. Never induce vomiting. Risk of aspiration!
- ▶ If a person is lying on their back and vomiting, place them in the recovery position. Seek medical advice immediately.

**Environmental protection measures**

- ▶ Never allow brake fluid to flow into the sewage system, water courses or groundwater.
- ▶ Notify the relevant authorities if fluid penetrates the ground, water courses or the sewage system.
- ▶ Consult a doctor immediately in the event of any pain or discomfort caused by combustion gas or leaking fluids.

**2.7.3 Battery vapours emitted**

Vapours may be emitted if the battery is damaged or used improperly. The vapours may cause respiratory tract irritation.

- ▶ Get into fresh air.
- ▶ Consult doctor in the event of pain or discomfort.

**After contact with eyes**

- ▶ Carefully rinse eyes with plenty of water for at least 15 minutes. Protect unaffected eye. Seek medical advice immediately.

**After skin contact**

- ▶ Remove any solid particles immediately.
- ▶ Rinse the affected area with plenty of water for at least 15 minutes. Then dab the affected skin gently. Do not rub dry.
- ▶ Remove contaminated clothing immediately.
- ▶ Immediately consult a doctor if there is any redness, pain or discomfort.

**2.7.4 Battery fire**

The safety electronics may fail if the battery is damaged or faulty. The residual voltage can cause a short circuit. The battery may self-ignite and explode.

- 1 Keep your distance if the battery becomes deformed or starts to emit smoke.
  - 2 If charging, remove the plug connector from the socket.
  - 3 Contact the fire service immediately.
- ▶ Use Class fire extinguishers to put out the fire.
  - ▶ Never extinguish damaged batteries with water or allow them to come into contact with water.

Inhaling vapours can cause intoxication.

- ▶ Stand on the side of the fire where the wind is blowing from.
- ▶ Use breathing apparatus if possible.

**2.7.5 Leaked brake fluid**

The brake system must be repaired immediately if brake fluid leaks out. Dispose of leaking brake fluid in an environmentally responsible way in accordance with statutory regulations.

- ▶ Contact your specialist dealer.

**2.7.6 Oil and lubricant leaks from the fork**

Dispose of oils and lubricants which have leaked from the rear frame damper in an environmentally responsible way in compliance with statutory regulations.

- ▶ Contact your specialist dealer.

**2.7.7 Oil and lubricant leaks from the rear frame damper**

Dispose of oils and lubricants which have leaked from the rear frame damper in an environmentally responsible way in accordance with statutory regulations.

- ▶ Contact your specialist dealer.

### 3 Overview



Figure 2: Pedelec viewed from right: BULLS Copperhead Evo AM3 used as example

1	Front wheel	8	Rear wheel
2	Fork	9	Kickstand
3	Handlebars	10	Chain
4	Stem	11	Motor
5	Frame	12	Pedal
6	Seat post	13	Battery and nameplate
7	Saddle		

### 3.1 Description

#### 3.1.1 Wheel

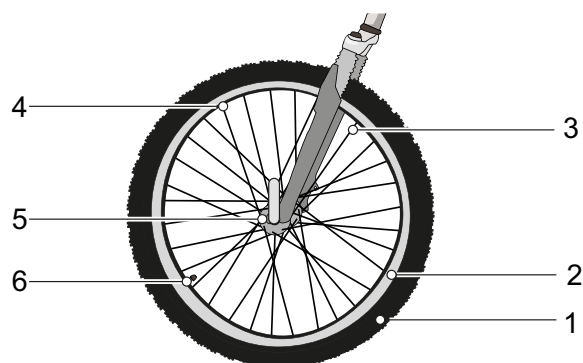

Figure 3: Visible Wheel components

- |   |               |
|---|---------------|
| 1 | Tyres         |
| 2 | Rim           |
| 3 | Spoke         |
| 4 | Spoke nipples |
| 5 | Hub           |
| 6 | Valve         |

The wheel comprises the *wheel itself*, an inner tube with a valve and a tyre.

##### 3.1.1.1 Valve

Each wheel has a valve. It is used to fill the *tyre* with air. There is a valve cap on each valve. The screw-on valve cap keeps out dust and dirt.

The pedelec has either

- a classic Dunlop valve,
- a French valve (also known as a Sclaverand or Presta valve) or
- a Schrader valve.

### 3.1.2 Suspension

#### 3.1.2.1 Suspension fork

A suspension fork is based either on a steel spring or air suspension.

Unlike a rigid fork, a suspension fork has two functions which improve floor contact and comfort: suspension and damping. The suspension prevents an impact, such as one caused by a stone lying in the pedelec's path, from being channelled directly into the rider's body via the fork. The impact is absorbed by the suspension system instead. This causes the suspension fork to compress.



Figure 4: Pedelec without suspension (1) and with suspension (2)

After compressing, the suspension fork returns to its original position. If there is a damper, it decelerates movement, preventing the suspension system from springing back in an uncontrolled manner and stopping the fork from vibrating up and down. Dampers which dampen compressive deflection movements, i.e. a compression load, are called compression dampers or compression dashpots.

Dampers which dampen rebound deflection movements, i.e. a rebound load, are called rebound dampers or dashpots.

The compression can be disabled in any suspension fork. A suspension fork will then behave like a rigid fork.

### 3.1.2.2 Steel suspension fork

The stem and handlebars are fastened to the fork steerer (1). The wheel is fastened to the quick release axle (6).

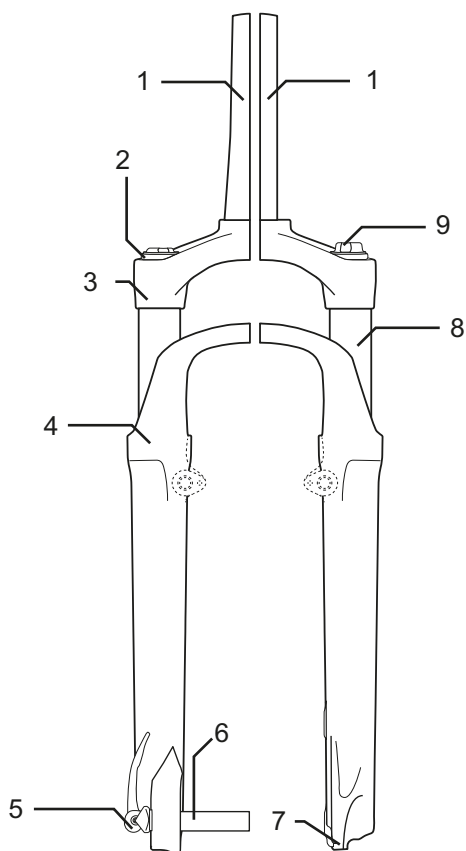

Figure 5: Example showing Suntour fork

Other elements: the setting wheel for negative deflection (9), crown (3), Q-Loc (5), dust seal (4), fork end (7) and stanchion (8)

### 3.1.3 Brake system

Every pedelec has a hydraulic brake system. The brake fluid is in a closed hose system. If the rider pushes the brake lever, the brake fluid activates the brake on the wheel.

The mechanical brakes are used as an emergency stop system and bring the bicycle to a halt quickly and safely in the event of an emergency.

#### 3.1.3.1 Disc brake

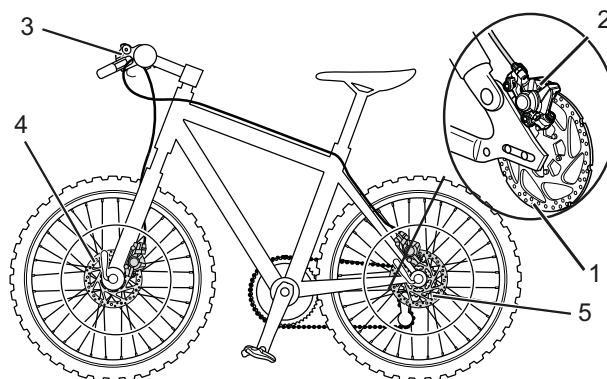

Figure 6: Brake system with disc brake – example

- 1 Brake disc
- 2 Brake calliper with brake linings
- 3 *Handlebars with brake lever*
- 4 Front wheel brake disc
- 5 Rear wheel brake disc

On a pedelec with a disc brake, the brake disc is screwed permanently to the wheel *hub*. The *brake lever* is pushed to increase brake pressure. The brake fluid is used to transfer pressure through the brake cables to the cylinders in the brake calliper. The braking force is boosted by a speed reduction and applied to the brake linings. These apply the brake disc mechanically. If the *brake lever* is pushed, the brake linings are pressed against the brake disc and the wheel movement is decelerated until it comes to a stop.

### 3.1.4 Electric drive system

The pedelec is driven by muscle power applied to the chain drive. The force which is applied by pedalling in the direction of travel drives the front chain wheel. The chain transmits the force onto the rear chain wheel and then onto the rear wheel.

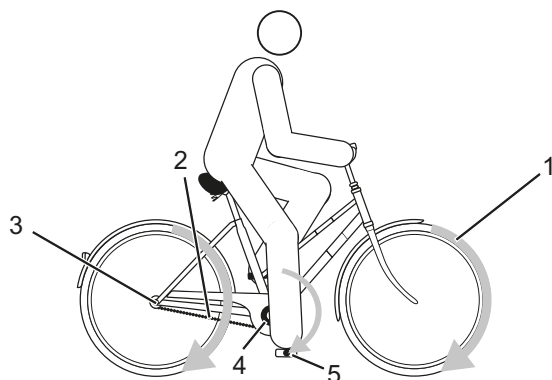

Figure 7: Diagram of mechanical drive system

- 1 Direction of travel
- 2 Chain
- 3 Rear chain wheel
- 4 Front chain wheel
- 5 Pedal

The pedelec also has an integrated electric drive system.

As soon as the required muscle power from the rider pedalling passes a certain level, the motor is activated gently and assists the rider's pedalling motion. The pre-set level of assistance determines the motor output.

The pedelec does not have a separate emergency shut-off button. The mechanical brakes are used as an emergency stop system and bring the bicycle to a halt quickly and safely in the event of an emergency.

The motor switches off automatically as soon as the rider no longer pedals, the temperature is outside the permitted range, there is an overload or the shut-off speed of 25 km/h has been reached.

The electric drive system is made up of 7 components:

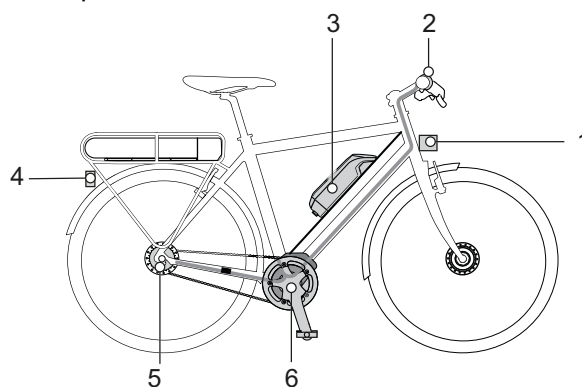

Figure 8: Diagram of electric drive system

- 1 *Headlight*
- 2 *Display*
- 3 *Frame battery*
- 4 *Rear light*
- 5 *Electric gear shift (alternative)*
- 6 *Motor*
- 7 A charger which is designed for the battery.

A push assist system can be activated. The speed depends on the selected gear. The push assist continues to drive the pedelec as long as the rider presses the **push assist button** on the *handlebars*. The speed can be a maximum of 6 km/h in this case. The electric drive system stops when the **push assist button** is released.

### 3.1.5 Rechargeable battery

Bosch batteries are lithium ion batteries which are developed and manufactured to the latest technical standards. Each individual cell is protected by a steel cup and encased in a plastic battery housing. These batteries meet and exceed applicable industrial safety standards. The battery has an internal electronic protection circuit, which is specifically designed for the charger and the pedelec. The battery temperature is monitored at all times. The battery is protected against deep discharge, overcharging, overheating and short circuit. In the event of a hazard, a protective circuit switches the battery off automatically.

The battery has a high energy content when charged. You will find codes of practice for their safe handling in Section 2 Safety and Section 6.9 Rechargeable battery in the operating instructions.

If the electric drive system is not used for about 10 minutes and no button has been pressed on the display or the control panel, the electric drive system and the battery are automatically switched off to save energy.

The type and duration of operating conditions have a significant effect on the battery life. Just like any other lithium-ion battery, the battery will age naturally if it is not being used. The battery's service life can be extended if the battery is well maintained and stored at the correct temperature. The charging capacity will decrease with age, even if the battery is maintained properly. If the operating time is severely shortened after charging, this is a sign that battery has reached the end of its useful life.

Battery performance is reduced when the temperature drops since this increases electrical resistance. As a result, you can expect the range to be shorter than normal in winter. We recommend using thermal protection sleeves when riding longer distances in the cold.

The pedelec features either an integrated battery, a pannier rack battery or a frame battery. Each battery has its own lock.

### 3.1.5.1 Frame battery

Three different types of frame batteries can be fitted:



Table 6: Overview of frame batteries

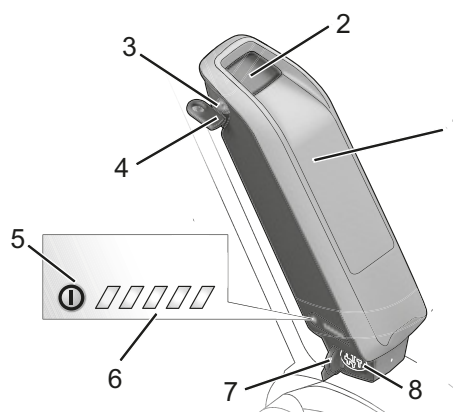

Figure 9: Details of frame battery

- 1 Battery housing
- 2 Battery lock
- 3 Battery key
- 4 On-Off button (battery)
- 5 Battery level indicator (battery)
- 6 Charging port cover
- 7 Charging port

### 3.1.6 Display

The model series to which these instructions apply features the BOSCH Purion display. In addition to the functions described here, software changes may be introduced to rectify errors and extend functions at any time.

The display controls the drive system with four operating elements and shows the journey data.

The battery powers the display. The display also has two internal non-rechargeable coin cells. This ensures that the electric drive system can be switched on using the display.

The pane of glass on the display may steam up from the inside if there are abrupt fluctuations in temperature. This is not a malfunction.



Figure 10: BOSCH Purion display

### 3.1.7 Riding light

When the riding light is activated, the *headlight* and the rear light are switched on together.

### 3.1.8 Charger

Each pedelec is supplied with a charger. As a general rule, any BOSCH charger may be used:

- The 2 A compact charger
- The 4 A standard charger
- The 6 A fast charger

Observe the operating instructions in the Section 11 Documents.

### 3.2 Proper use

The pedelec must only be used in perfect, fully functional condition. National requirements may apply to the pedelec which the standard equipment may not meet. For riding on public roads, some special regulations apply in relation to the riding light, reflectors and other components.

The general laws and the regulations for the prevention of accidents and environmental protection in the respective country of use must be adhered to. All check lists and instructions for

actions in these *operating instructions* met. Approved accessories can be installed by specialist staff.

The rechargeable batteries are designed to supply power to the pedelec motor only and must not be used for other purposes.

Each pedelec is assigned a pedelec type, which determines its proper use, function and area of use.







City and trekking bicycles	Child's bicycles/ bicycles for young adults	Mountain bikes	Racing bicycle	Cargo bike	Folding bicycle
 <p>City and trekking bicycles are designed for daily, comfortable use. They are suitable for riding on public roads.</p>	 <p>The legal guardians of minor riders must read and understand these <i>operating instructions</i> before commissioning.</p> <p>The contents of these <i>operating instructions</i> must be communicated to the riders in an age-appropriate manner.</p> <p>The cycles for children and young adults are suitable for riding on public roads. The size of the pedelec must be checked regularly for orthopaedic reasons.</p> <p>A check must be made at least every three months to make sure that the maximum permitted total weight is being observed.</p>	 <p>Mountain bikes are designed for sporting use. The design characteristics include a short wheelbase, a sitting position with the rider inclined towards the front, and a brake requiring low actuation force.</p> <p>A mountain bike is a piece of sporting equipment. It requires an adaptation period and the rider must be physically fit. Use requires the appropriate training; in particular riding in bends and braking should be practised.</p> <p>The strain on the rider, in particular the hands and wrists, arms, shoulders, neck and back, is accordingly high. Inexperienced riders tend to brake excessively and lose control as a result.</p>	 <p>A racing bicycle is designed for fast rides on roads and paths with a good, undamaged road surface.</p> <p>A racing bicycle is a piece of sporting equipment and not a means of transport. A racing bicycle is characterised by its lightweight structure and a design which is stripped to the minimum parts required for riding.</p> <p>The frame geometry and the layout of the operating elements are designed in such a way that the bicycle can be ridden at high speeds. The frame design requires practice to ensure the ride is able to ride slowly, apply the brakes and get on and off the bike safely.</p> <p>The sitting position is athletic. The strain on the rider, in particular the hands and wrists, arms, shoulders, neck and back, is accordingly high. The sitting position therefore requires physical fitness.</p>	 <p>The cargo bike is suitable for daily transportation of loads on public roads.</p> <p>The transportation of loads requires skill and physical fitness in order to balance the additional weight. The very varied loading conditions and weight distributions require special practice and skill when braking and riding in bends.</p> <p>A longer period is required to adaptation to the length, width and turning circle. You need to be cautious when riding a cargo bike. You must pay attention to the traffic on public roads and the condition of the route accordingly.</p>	 <p>The folding bicycle is suitable for use on public roads.</p> <p>A folding bicycle can be folded up and is thus suitable for space-saving transportation, for example on public transport or in a car.</p> <p>The folding function of the folding bicycle makes it necessary to use smaller wheels and longer brake cables and Bowden cables. Therefore, in case of an increased load, a reduction in riding stability and braking power, diminished comfort and reduced durability are to be expected.</p>

Table 7: Proper use for each pedelec type



### 3.3 Improper use

Failure to adhere to the proper use poses a risk of personal injury and material damage. It is prohibited to use the pedelec in the following ways:

- when the electrical drive system has been manipulated
- riding with a damaged or incomplete pedelec
- riding over steps
- riding through deep water
- charging with an incorrect charger
- lending the pedelec to untrained riders
- carrying other people
- riding with excessive baggage
- riding with no hands
- riding on ice and snow
- improper servicing
- improper repair
- tough areas of use, such as professional competitions
- stunt riding or acrobatics.

City and trekking bicycles	Child's bicycles/ bicycles for young adults	Mountain bikes	Racing bicycle	Cargo bike	Folding bicycle
					
City and trekking bicycles are not sports bicycles. If used for sports, the rider can expect reduced riding stability and diminished comfort	Cycles for children and young adults are not toys.	Mountain bikes must be retrofitted with lighting, a bell and other fittings as specified by national laws and regulations before they are used on public roads.	Racing bikes must be retrofitted with lighting, a bell and other fittings as specified by national laws and regulations before they are used on public roads.	A cargo bike is not a touring bicycle or a sports bicycle.	The folding bicycle is not a sports bicycle.

Table 8: Information on improper use

### 3.3.1 Maximum permitted total weight

The pedelec may only be loaded to its maximum permitted total weight (PTW). The maximum permitted total weight is the weight of the fully assembled pedelec with the rider and baggage.

Type no.	Model	PTW
21-26-3001	Twenty 4 E 24"	115 kg

### 3.3.2 Data privacy information

When the pedelec is connected to the BOSCH diagnosis tool, data is transferred to Bosch eBike Systems (Robert Bosch GmbH) regarding the use of rechargeable battery, including its temperature and cell voltage, to help improve the product. You will find more detailed information on the BOSCH website: [www.bosch-ebike.com/en/](http://www.bosch-ebike.com/en/).

## 3.4 Technical data

### 3.4.1 Pedelec

Transportation temperature	5 °C - 25 °C
Ideal transportation temperature	10 °C - 15 °C
Storage temperature	10 °C - 30 °C
Ideal storage temperature	10 °C - 15 °C
Operating temperature	5 °C - 35 °C
Work environment temperature	15 °C - 25 °C
Charging temperature	0 °C - 40 °C
Power output/system	250 W (0.25 kW)
Shut-off speed	25 km/h

Table 9: Pedelec technical data

### 3.4.2 Emissions

A-weighted emission sound pressure level	< 70 dB(A)
Total vibration level for the hands and arms	< 2.5 m/s <sup>2</sup>
Highest effective value of weighted acceleration for the entire body	< 0.5 m/s <sup>2</sup>

Table 10: Emissions from the pedelec\*

\*The safety requirements as per Electromagnetic Compatibility Directive 2014/30/EU have been met. The pedelec and the charger can be used in residential areas without restriction.

### 3.4.3 Tightening torque

Axle nut tightening torque	35 Nm - 40 Nm
Handlebars clamping screw maximum tightening torque*	5 Nm - 7 Nm

Table 11: Tightening torque values

\*if there is no other data on the component

### 3.4.4 Bicycle lighting

Voltage about	12 V
<b>Maximum output</b>	
Front light	17.4 W
Rear light	0.6 W

Table 12: Technical data for lighting

### 3.4.5 Purion display

Batteries	2 x 3 V CHR2016
Operating temperature	-5 °C - +40 °C
Storage temperature	10 °C - +40 °C
Charging temperature	0 °C - + 40 °C
Protection rating (with USB cover closed)	IP54
Weight about	0.1 kg

Table 13: Purion display technical data (BUI215)

### 3.4.6 Motor Active Line Plus

Maximum continuous power	250 W
Max. torque	50 Nm
Nominal voltage	36 V DC
Protection class	IP54
Weight about	3.2 kg
Operating temperature	-5 °C - +40 °C
Storage temperature	-10 °C - +40 °C

Table 14: Technical data for Active Line Plus BDU350 motor

### 3.4.7 PowerPack 400 battery

Nominal voltage	36 V
Nominal capacity	11 Ah
Energy	400 Wh
Weight	2.5/ 2.6 kg
Protection class	IP54
Operating temperature	-5 °C - +40 °C
Storage temperature	+10 °C - +40 °C
Permitted charging temperature range	0 °C - + 40 °C

Table 15: Technical data for PowerPack 400, BBS265 and BBR265 batteries

### 3.4.8 PowerPack 500 battery

Nominal voltage	36 V
Nominal capacity	13.4 Ah
Energy	500 Wh
Weight	2.6/ 2.7 kg
Protection class	IP54
Operating temperature	-5 °C - +40 °C
Storage temperature	+10 °C - +40 °C
Permitted charging temperature range	0 °C - +40 °C

Table 16: Technical data for PowerPack 500, BBS275 and BBR275 batteries

### 3.5 Description of controls and screens

#### 3.5.1 Handlebars

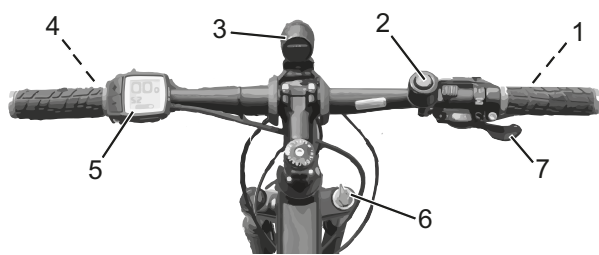

Figure 11: Detailed view of pedelec from rider position, example

- 1 Rear brake lever
- 2 Bell
- 3 Headlight
- 4 Display
- 5 Front brake lever
- 6 Control panel
- 8 Fork lock on the suspension fork
- 9 Shifter

#### 3.5.2 Battery level indicator

Each battery has its own level indicator:

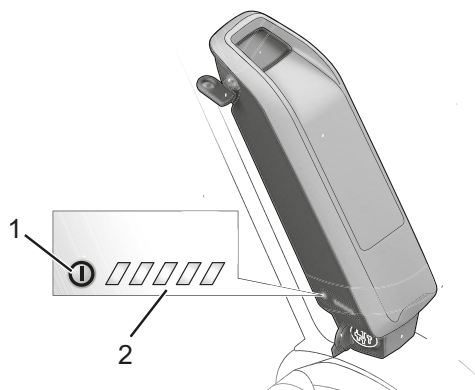

Figure 12: Example of a battery level indicator

- 1 On-Off button (battery)
- 2 Battery level indicator

The five green LEDs on the battery level indicator show the charge level when the battery is switched on. Each LED represents about 20% of battery capacity. All five LEDs will light up when the battery is fully charged. The charge level for the activated battery is also shown on the *display screen*.

If the battery level falls below 5%, all the LEDs on the battery level indicator will go out. However, the battery level is still shown on the *display screen*.

### 3.5.3 Display

The display has nine on-screen indicators:

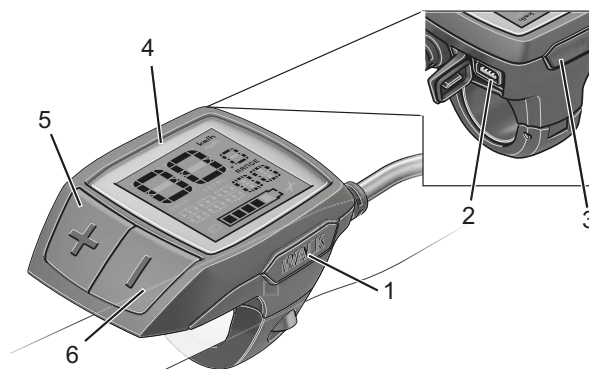

Figure 13: On-screen indicators overview

- 1 Indicator unit km/h or mph
- 2 Tachometer screen
- 3 TRIP indicator
- 4 Display of levels of assistance or function display
- 5 Lighting indicator
- 6 Service indicator
- 7 Battery level indicator
- 8 RANGE indicator
- 9 TOTAL indicator

#### 3.5.3.1 Indicator unit km/h or mph

The speed can be displayed in km/h or mph. You can choose between the units in the system settings.

#### 3.5.3.2 Tachometer screen

The tachometer indicator shows the current speed at all times.

#### 3.5.3.3 Information display

The display shows one of three types of information. The displayed information can be changed.

Indicator	Function
TRIP	Distance travelled since the last RESET
TOTAL	total distance travelled (cannot be changed)
RANGE	Estimated range of the available battery charge, calculated based on the most recent manner of riding

Table 17: Information display

### 3.5.4 System message

The drive system monitors itself continuously and if an error is detected, it is indicated by a system message. The system may switch off automatically depending on the type of error.

There is a table of all system messages in Section 6.2. You will find assistance for system messages in Section 8.5 *Initial help*.

### 3.5.5 ABS indicator lamp

The anti-blocking system indicator lamp must light up after the system has started up and must go out once speed has reached about 5 km/h. If the ABS indicator lamp does not light up when the electric drive system starts, the ABS is defective. An error code on the display screen also tells the rider that it is defective.

If the indicator lamp does not go out after you set off or it lights up while you are riding, this means there is an error in the anti-blocking system. The anti-blocking system is then no longer active. The brake system itself remains functional. It is only the anti-blocking system control which no longer operates.

If the ABS indicator lamp is lit, the ABS function is not active.

#### Notice

The anti-blocking system indicator lamp may light up if the front and rear wheels are rotating at widely different speeds from one another – for example, if the rider cycles on the rear wheel only or if a wheel is rotating for an unusually long time without making contact with the ground (fitting stand). The anti-blocking system switches off in such cases.

Note: You need to stop and restart the pedelec (switch off and on again) to reactivate the anti-blocking system.

### 3.6 Environmental requirements

You can ride the pedelec within a temperature range between 5 °C and 35 °C. The electric drive system is limited in its performance outside this temperature range.

<b>Optimal operating temperature</b>	22 °C - 26 °C
--------------------------------------	---------------

During winter use, especially at temperatures below 0 °C, we recommend that you don't insert a battery charged and stored at room temperature into the pedelec until just before setting off. We recommend using thermal protection sleeves when riding longer distances in the cold.











Temperatures under -10 °C and over +50 °C must be avoided.

You must also keep within the following temperature ranges:

Transportation temperature	10 °C - 40 °C
Storage temperature	10 °C - 40 °C
Work environment temperature	15 °C - 25 °C
Charging temperature	10 °C - 40 °C











**Table 18: Pedelec technical data**

The nameplate contains symbols for the pedelec's area of use. Check what roads and paths you may use before you ride the bicycle for the first time.

Area of use	City and trekking bicycles	Child's bicycles/ bicycles for young adults	Mountain bikes	Racing bicycle	Cargo bike	Folding bicycle
 <b>1</b>	 Suitable for tarmacked and paved roads.	 Suitable for tarmacked and paved roads.		 Suitable for tarmacked and paved roads.	 Suitable for tarmacked and paved roads.	 Suitable for tarmacked and paved roads.
 <b>2</b>	Suitable for tarmacked roads, cycle paths and firm gravel paths and roads, and longer sections with moderate slopes and jumps up to 15 cm.	Suitable for tarmacked roads, cycle paths and firm gravel paths and roads, and longer sections with moderate slopes and jumps up to 15 cm.	Suitable for tarmacked roads, cycle paths and firm gravel paths and roads, and longer sections with moderate slopes and jumps up to 15 cm.	Suitable for tarmacked roads, cycle paths and firm gravel paths and roads, and longer sections with moderate slopes and jumps up to 15 cm.		
 <b>3</b>			Suitable for tarmacked roads, cycle paths and easy to demanding off-road riding, sections with moderate slopes and jumps up to 61 cm.			
 <b>4</b>			Suitable for tarmacked roads, cycle paths and easy to demanding off-road riding, limited downhill use and jumps up to 122 cm.			

**Table 19: Area of use**

The pedelec is unsuitable for the following areas of use:

Area of use	City and trekking bicycles	Child's bicycles/ bicycles for young adults	Mountain bikes	Racing bicycle	Cargo bike	Folding bicycle
						
 <b>1</b>	Never drive off-road or perform jumps.	Never drive off-road or perform jumps.		Never drive off-road or perform jumps.	Never drive off-road or perform jumps.	Never drive off-road or perform jumps.
 <b>2</b>	Never drive off-road or perform jumps over 15 cm.	Never drive off-road or perform jumps over 15 cm.	Never drive off-road or perform jumps over 15 cm.	Never drive off-road or perform jumps over 15 cm.		
 <b>3</b>			Never ride downhill or perform jumps over 61 cm.			
 <b>4</b>			Never traverse extremely difficult off-road terrain or perform jumps over 122 cm.			



## 4 Transporting and storing

### 4.1 Physical transport characteristics

#### Weight and dimensions during transportation

Type no.	Frame	Box dim. [cm]	Weight** [kg]	Shipping weight [kg]
21-26-3001		t.b.a.	t.b.a.	t.b.a.

Table 20: Type number, model and pedelec type

\*\*Vehicle weight without battery. The vehicle's total weight depends on the battery used.

Battery type	Weight
PowerPack 300 battery	2.5 kg
PowerPack 400 battery	2.5 kg
PowerPack 500 battery	2.6 kg

#### 4.1.1 Designated handles/lifting points

The box does not have any handles.

## 4.2 Transporting



### Crash caused by unintentional activation

There is a risk of injury if the drive system is activated unintentionally.

- ▶ Remove the battery.

### 4.2.1 Using the brake transport securing system

Applicable for pedelec disc brakes only



### Oil leak if no transport securing device

The brake securing device prevents the brakes from being applied accidentally during transportation or shipment. This could cause irreparable damage to the brake system or an oil leak, which will harm the environment.

- ▶ Never push the brake lever when the wheel has been dismantled.
  - ▶ Always use the transport securing system when transporting or shipping.
- 
- ▶ Insert the **transport securing devices** between the brake linings.
- ⇒ Transport securing device is squeezed between the two linings and prevents undesired sustained braking which can cause brake fluid to leak out.

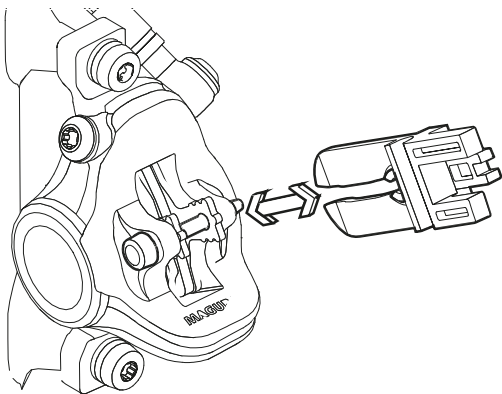

Figure 14: Fastening the transport securing device

### 4.2.2 Transporting the pedelec

Bicycle rack systems which use the handlebars or frame to hold the pedelec in an upside-down position exert inadmissible forces on its components during transportation. This can cause the supporting parts to break.

- ▶ Never use bicycle rack systems which use the pedelec's handlebars or frame to hold it in an upside-down position. The specialist dealer will advise you on how to select a suitable rack system properly and how to use it safely.
- ▶ Take into account the weight of the ready-to-use pedelec when transporting it.
- ▶ Protect the electrical components and connections on the pedelec from the weather conditions with suitable protective covers.
- ▶ Transport the battery in a dry, clean position where it is protected from direct sunlight.

### 4.2.3 Shipping a pedelec

- ▶ When shipping the pedelec, we recommend that you have the specialist dealer partially dismantle the pedelec and place it in the proper packaging.

### 4.2.4 Transporting the battery

*Batteries* are subject to hazardous goods regulations. Undamaged batteries may be transported by private persons in road traffic.

Commercial transport requires compliance with regulations concerning packaging, labelling and the transportation of hazardous goods. Open contacts must be covered and the battery securely packaged.

### 4.2.5 Shipping the battery

The battery is considered a hazardous good and only trained persons may pack and ship a battery. Contact your specialist dealer.

## 4.3 Storing

- ▶ Store pedelec, battery and charger in a clean, dry place where they are protected from sunlight. Do not store outdoors to ensure a long service life.

Optimum pedelec storage temperature	10 °C - 20 °C
-------------------------------------	---------------

**Table 21: Storage temperature for batteries and the pedelec**

- ✓ Temperatures under -10 °C or over +40 °C must generally be avoided.
- ✓ Storage at about 10 °C to 20 °C is beneficial to a long battery life.
- ✓ Store pedelec, battery and charger separately.

### 4.3.1 Break in operation

#### Notice

The battery discharges when not in use. This can cause irreparable damage to the battery.

- ▶ The battery must be recharged every 6 months.

The battery may become damaged if it is connected permanently to the charger.

- ▶ Never connect the battery to the charger permanently.

If the pedelec is removed from service for longer than four weeks, you need to prepare it for a break in operation.

#### 4.3.1.1 Preparing a break in operation

- ✓ Remove the rechargeable battery from the pedelec.
- ✓ Charge battery to around 30% - 60%.
- ✓ The pedelec needs to be cleaned with a damp cloth and preserved with wax spray. Never wax the friction surfaces of the brake.
- ✓ Before longer periods without use, it is recommendable to have your specialist dealer carry out an inspection and basic cleaning and apply preservative agent.

#### 4.3.1.2 Carrying out a break in operation

- 1 Store the pedelec, battery and charger in a dry, clean environment. We recommend storing them in uninhabited rooms with smoke alarms. Dry locations with an ambient temperature of about 10 °C to 20 °C are ideal.
- 2 Check the battery level after 6 months. If only one LED on the battery level indicator lights up, recharge the battery to around 30% - 60%.



## 5 Assembly

### WARNING

#### Risk of eye injury

Problems may arise if the settings are not made to components correctly and you may sustain serious injuries as a result.

- ▶ Always wear safety glasses to protect your eyes during assembly.

### CAUTION

#### Crash and crushing hazard caused by unintentional activation

There is a risk of injury if the drive system is activated unintentionally.

- ▶ Remove the battery.

- ✓ Assemble the pedelec in a clean, dry environment.
- ✓ The *work environment* temperature should be between 15 °C and 25 °C.
- ✓ The fitting stand used must be approved for a maximum weight of at least 30 kg.

### 5.1 Required tools

The following tools are required to assemble the pedelec:

- Knife
- Hexagon socket spanner 2 (2.5 mm, 3 mm, 4 mm, 5 mm, 6 mm and 8 mm)
- Torque wrench with working range between 5 and 40 Nm
- Twelve-point square socket T25
- Ring spanner (8 mm, 9 mm, 10 mm), 13 mm, 14 mm and 15 mm) and
- Cross, flat head and ordinary screwdriver.

## 5.2 Unpacking

The packaging material consists mainly of cardboard and plastic film.

- ▶ The packaging has to be disposed of in accordance with the regulations of the authorities.

### 5.2.1 Scope of delivery

Pedelects are fully assembled in the factory for test purposes and then dismantled for transportation.

The pedelec is 95 - 98% pre-assembled. The scope of delivery includes:

- the pre-assembled pedelec
- the front wheel
- the pedals
- quick release (optional)
- the charger
- the *operating instructions*.

The battery is supplied separately from the pedelec.

## 5.3 Preparing the battery

### 5.3.1 Checking the battery

The battery must be checked before it is charged for the first time.

- 1 Press the **On-Off button (battery)**.
  - ⇒ If none of the LEDs on the battery level indicator light up, the battery may be damaged.
  - ⇒ The battery may be fully charged if at least one, but not all, of the LEDs on the battery level indicator is lit up.

## 5.4 Commissioning

### CAUTION

#### Burns from hot drive

The drive cooler can become extremely hot during use. Touching it may cause burns.

- ▶ Leave the drive unit to cool before assembly.

Only trained specialist staff may perform initial commissioning since initial commissioning of the pedelec requires special tools and specialist knowledge.

Experience has shown that a pedelec which has not yet been sold is automatically handed to customers as soon as it appears ready to ride.

- ▶ For this reason, every pedelec must be prepared, so it is fully ready for use immediately after being assembled.
- ▶ The assembly report (see Section [11.2](#)) describes all safety-relevant inspections, tests and maintenance tasks for the bicycle in a separate list. All assembly work must be completed to ensure the pedelec is ready to ride.
- ▶ Complete an assembly report for quality assurance purposes.

## 5.4.1 Installing the wheel in the Suntour fork

### CAUTION

#### Crash caused by unfastened quick release

A faulty or incorrectly installed quick release may become caught in the brake disc and block the wheel. This will cause a crash.

- ▶ Never fit a defective quick release.

#### Crash caused by faulty or incorrectly installed quick release

The brake disc becomes very hot during operation. Parts of the quick release may become damaged as a result. The quick release comes loose. This will cause a crash with injuries.

- ▶ The front wheel quick release lever and the brake disc must be situated on opposite sides.

#### Crash caused by incorrectly set clamping force

Excessively high clamping force will damage the quick release and cause it to lose its function.

Insufficient clamping force will result in unfavourable transmission of force. The suspension fork or the quick release may break. This will cause a crash with injuries.

- ▶ Never fasten a quick release using a tool (e.g. hammer or pliers).
- ▶ Only use the clamping lever with the specified set clamping force.

- 1 Before installing, ensure that the quick release flange is extended. Open the lever fully.

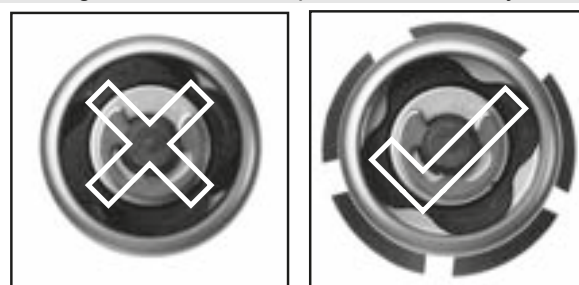

Figure 15: Open and closed flange

- 2 Push in the quick release until you can hear a click. Make sure that the flange is extended.



Figure 16: Pushing the quick release in

- 3 Adjust tensioning with half-open clamping lever until the flange reaches the fork end.

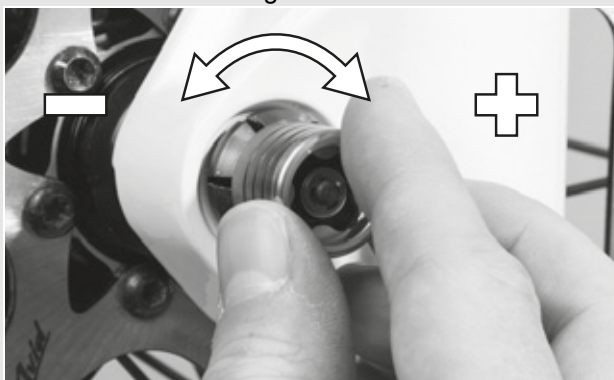

Figure 17: Adjusting the clamping

- 4 Fully close the quick release. Check that the quick release is firmly in place and adjust it on the flange if necessary.

⇒ The lever is secured.



Figure 18: Closing the quick release

## 5.4.2 Checking the stem and handlebars

### 5.4.2.1 Checking the connections

- 1 Stand in front of the pedelec to check whether the handlebars, stem and fork steerer are firmly attached to one another. Clamp the front wheel between your legs. Grasp the handlebar grips.
  - 2 Try to twist the handlebars towards the front wheel.
- ⇒ The stem must not move or twist.

### 5.4.2.2 Firm hold

- 1 Place your entire body weight on the handlebars with the quick release lever closed to check that the stem is firmly in place.
- ⇒ The handlebars shaft must not move downwards in the fork steerer.
- 2 If the handlebars shaft should move in the fork steerer, increase the quick release lever tensioning. To do so, turn the knurled nut slightly in a clockwise direction with the quick release lever open.
  - 3 Close the lever and check the stem is firmly in position.

### 5.4.2.3 Checking the headset backlash

- 1 To check the handlebar headset backlash, close the quick release lever on the stem.
- 2 Place the fingers of one hand on the upper headset cup. Pull the front wheel brake with the other hand and try to push the pedelec backwards and forwards.
- 3 The headset cup halves must not move towards one another while you are doing this. Note that there may be noticeable backlash due to worn-out bearing bushes or brake lining backlash in suspension forks and disc brakes.
- 4 If there is headset backlash in the steering headset, you must adjust it as soon as possible; otherwise, the headset will become damaged. You must make the adjustment as described in the stem manual.

## 5.5 Pedelec sale

- ▶ Complete Pedelec pass on the operating instructions envelope.
- ▶ Note down the manufacturer and the number of the battery key.
- ▶ Adjust the pedelec to the rider; see Section 6.5.
- ▶ Set the stand and shifter.
- ▶ Instruct the operator or rider on how to use all the pedelec's functions.

## 6 Operation

### 6.1 Risks and hazards

#### WARNING

#### Injuries and death caused by other road users

Other road users, trucks, cars or pedestrians often underestimate the speed of pedelecs. Likewise, other road users frequently do not see pedelecs. This may cause a crash with serious injuries or even death.

- ▶ Wear a cycling helmet and high-visibility, reflective clothing.
- ▶ Always take a defensive approach to riding.
- ▶ Avoid the blind spots of vehicles turning off. Reduce speed as a precaution when other road users turn right.

#### Injuries and death caused by riding incorrectly

A pedelec is not a bicycle. Incorrect riding and underestimated speeds soon result in hazardous situations. This may cause a fall with serious injuries or even death.

- ▶ If you haven't ridden on a pedelec for some time, get accustomed to the speed first before you ride at speeds over 12 km/h. Increase the levels of assistance gradually.
- ▶ Practice braking hard on a regular basis.
- ▶ Take and complete a riding safety course.

#### CAUTION

#### Crash caused by loose clothing

Shoe laces, scarves and other loose items may become entangled in the spokes on the *wheels* and on the *chain drive*. This may cause a crash with injuries.

- ▶ Wear sturdy footwear and close-fitting clothing.

#### CAUTION

#### Crash caused by difficult-to-spot damage

If the pedelec topples over or you have a fall or an accident, there may be difficult-to-spot damage to components such as the brake system, quick releases or *frame*. This may cause a crash with injuries.

- ▶ Take the pedelec out of service and have a specialist dealer carry out an inspection.

#### Crash caused by material fatigue

Intensive use can cause material fatigue. A component may suddenly fail in case of material fatigue. This may cause a crash with injuries.

- ▶ Remove the pedelec from service immediately if there are any signs of material fatigue. Have the specialist dealer check the state.
- ▶ Have the specialist dealer carry out a basic inspection regularly. During the inspection, the specialist dealer will inspect the pedelec for any signs of material fatigue on the frame, fork, suspension element mountings (if there are any) and components made of composite materials.

Carbon becomes brittle when exposed to heat radiation such as heating. This can cause the carbon part to break and result in a crash with injuries.

- ▶ Never expose carbon parts on the pedelec to strong sources of heat.

#### Crash caused by soiling

Heavy soiling can impair pedelec functions, such as braking. This may cause a crash with injuries.

- ▶ Remove coarse soiling before riding.



 **CAUTION**
**Crash caused by poor road conditions**

Loose objects, such as branches and twigs, may become caught in the wheels and cause a crash with injuries.

- ▶ Be aware of the road conditions.
- ▶ Ride slowly and brake in good time.

**Notice**

Heat or direct sunlight can cause the *tyre pressure* to increase above the permitted maximum pressure. This can destroy the *tyres*.

- ▶ Never park the pedelec in the sun.
- ▶ On hot days, regularly check the *tyre pressure* and adjust it as necessary.

When riding downhill, high speeds may be reached. The pedelec is only designed to exceed a speed of 25 km/h for short intervals. The *tyres* in particular can fail if exposed to a continuous load.

- ▶ Use the brakes to decelerate the pedelec if you reach speeds greater than 25 km/h.

**Notice**

Moisture penetrating at low temperatures may impair individual functions due to the open structural design.

- ▶ Always keep the pedelec dry and free from frost.
- ▶ If the pedelec is to be used at temperatures below 3 °C, the specialist dealer must carry out an inspection and prepare it for winter use.

Off-road riding subjects the joints in the arms to severe strain.

- ▶ Take a break from riding every 30 to 90 minutes, depending on the road surface conditions

**6.1.1 Personal protective equipment**

It is recommended that you wear a suitable cycling helmet, sturdy footwear and typical, close-fitting, reflective sports clothing.

**6.2 Tips for a greater range**

The pedelec's range depends on many influencing factors. A single battery charge may only last fewer than 20 kilometres but much more than 100 is also possible. There are a few tips which will generally help you maximize range.

**Suspension elements**

- ▶ Only open suspension fork and damper when necessary on terrain or gravel paths. Block suspension fork and damper on tarmacked roads or on hills.

**Pedalling frequency**

- ▶ Ride using pedalling frequencies of over 50 revolutions per minute. This optimises the electric drive's efficiency.
- ▶ Avoid pedalling very slowly.

**Weight**

- ▶ Minimise the total weight of pedelec and baggage.

**Stopping and starting**

- ▶ Ride long distances at a constant speed.
- ▶ Avoid stopping and starting frequently.

**Gear shift**

- ▶ Use a low gear and a low level of assistance on hills and when setting off.
- ▶ Switch up a gear depending on the speed and terrain.

**Tyre pressure**

- ▶ Always use the maximum permitted tyre pressure.

**Motor power indicator**

- ▶ Adjust your riding to the displayed motor power. A long bar indicates high power consumption.

**Battery and temperature**

Electrical resistance increases as the temperature drops. Battery performance is reduced. As a result, you should expect the range to be shorter than normal in winter.

- ▶ Use a thermal protection sleeve on the battery in winter.

### 6.3 Error message

#### 6.3.1 Display

The drive system monitors itself continuously and displays a number as an error message if a known error is detected. The system may switch off automatically depending on the type of error.

Code	Description	Method of resolution
410	One or more display buttons are blocked	<ul style="list-style-type: none"> <li>▶ Check whether buttons are jammed because dirt has accumulated between them, for example.</li> <li>▶ Clean buttons if necessary.</li> </ul>
414	Connection problem with the control panel	▶ Contact specialist dealer. Have ports and connections checked.
418	One or more buttons on the control panel are blocked	<ul style="list-style-type: none"> <li>▶ Check whether buttons are jammed because dirt has accumulated between them, for example.</li> <li>▶ Clean buttons if necessary.</li> </ul>
419	Configuration error	<ol style="list-style-type: none"> <li>1 Re-start the system.</li> <li>2 Contact your specialist dealer if the problem persists.</li> </ol>
422	Battery connection problem	▶ Have ports and connections checked.
423	Battery connection problem	▶ Have ports and connections checked.
424	Communication error with components communicating with one another	▶ Have ports and connections checked.
426	Internal time-out error	<p>It is not possible to display or adjust the tyre size in the basic settings menu in this error status.</p> <ol style="list-style-type: none"> <li>1 Re-start the system.</li> <li>2 Contact your specialist dealer if the problem persists.</li> </ol>
430	Display battery flat	▶ Recharge display battery (while in its mount or using USB port).
431	Software version error	<ol style="list-style-type: none"> <li>1 Re-start the system.</li> <li>2 Contact your specialist dealer if the problem persists.</li> </ol>
440	Battery internal error	<ol style="list-style-type: none"> <li>1 Re-start the system.</li> <li>2 Contact your specialist dealer if the problem persists.</li> </ol>
450	Internal software error	<ol style="list-style-type: none"> <li>1 Re-start the system.</li> <li>2 Contact your specialist dealer if the problem persists.</li> </ol>

**Table 22: List of display screen error messages**

Code	Description	Method of resolution
460	Error in USB port	<ol style="list-style-type: none"> <li>1 Re-start the system.</li> <li>2 Contact your specialist dealer if the problem persists.</li> </ol>
490	Internal display error	▶ Have display checked.
500	Battery internal error	<ol style="list-style-type: none"> <li>1 Re-start the system.</li> <li>2 Contact your specialist dealer if the problem persists.</li> </ol>
502	Fault in the lighting	<ol style="list-style-type: none"> <li>1 Check the light and its cabling.</li> <li>2 Re-start the system.</li> <li>3 Contact your specialist dealer if the problem persists.</li> </ol>
503	Speed sensor error	<ol style="list-style-type: none"> <li>1 Re-start the system.</li> <li>2 Contact your specialist dealer if the problem persists.</li> </ol>
504	Speed signal manipulation detected	<ul style="list-style-type: none"> <li>▶ Check position of spike magnets and re-adjust if necessary.</li> <li>▶ Check for manipulation.</li> <li>▶ Assistance from drive has been reduced.</li> </ul>
503	Speed sensor error	<ol style="list-style-type: none"> <li>1 Re-start the system.</li> <li>2 Contact your specialist dealer if the problem persists.</li> </ol>
510	Internal sensor error	<ol style="list-style-type: none"> <li>1 Re-start the system.</li> <li>2 Contact your specialist dealer if the problem persists.</li> </ol>
511	Battery internal error	<ol style="list-style-type: none"> <li>1 Re-start the system.</li> <li>2 Contact your specialist dealer if the problem persists.</li> </ol>
530	Battery error	<ol style="list-style-type: none"> <li>1 Switch off system.</li> <li>2 Remove the battery.</li> <li>3 Re-insert battery.</li> <li>4 Re-start electric drive system.</li> <li>5 Contact your specialist dealer if the problem persists.</li> </ol>
531	Configuration error	<ol style="list-style-type: none"> <li>1 Re-start the system.</li> <li>2 Contact your specialist dealer if the problem persists.</li> </ol>

**Table 22: List of display screen error messages**

Code	Description	Method of resolution
540	Temperature error The pedelec is outside the permitted temperature range	<ol style="list-style-type: none"> <li>1 Switch off the system to cool the motor and battery down or warm them to the permitted temperature range.</li> <li>2 Re-start the system.</li> <li>3 Contact your specialist dealer if the problem persists.</li> </ol>
550	An inadmissible electrical load has been detected	<ol style="list-style-type: none"> <li>1 Remove consumer.</li> <li>2 Re-start the system.</li> <li>3 Contact your specialist dealer if the problem persists.</li> </ol>
580	Software version error	<ol style="list-style-type: none"> <li>1 Re-start the system.</li> <li>2 Contact your specialist dealer if the problem persists.</li> </ol>
591	Authentication error	<ol style="list-style-type: none"> <li>1 Switch off system.</li> <li>2 Remove the battery.</li> <li>3 Re-insert battery.</li> <li>4 Re-start the system.</li> <li>5 Contact your specialist dealer if the problem persists.</li> </ol>
592	Incompatible component	<ol style="list-style-type: none"> <li>1 Insert a compatible display.</li> <li>2 Re-start the system.</li> <li>3 Contact your specialist dealer if the problem persists.</li> </ol>
593	Configuration error	<ol style="list-style-type: none"> <li>1 Re-start the system.</li> <li>2 Contact your specialist dealer if the problem persists.</li> </ol>
595, 596	Communication error	<ol style="list-style-type: none"> <li>1 Check cabling to the gears.</li> <li>2 Re-start the system.</li> <li>3 Contact your specialist dealer if the problem persists.</li> </ol>
602	Internal error during charging	<ol style="list-style-type: none"> <li>1 Disconnect charger from battery.</li> <li>2 Re-start the system.</li> <li>3 Connect charger to the battery.</li> <li>4 Contact your specialist dealer if the problem persists.</li> </ol>
602	Internal fault	<ol style="list-style-type: none"> <li>1 Re-start the system.</li> <li>2 Contact your specialist dealer if the problem persists.</li> </ol>
603	Internal fault	<ol style="list-style-type: none"> <li>1 Re-start the system.</li> <li>2 Contact your specialist dealer if the problem persists.</li> </ol>

Code	Description	Method of resolution
605	Temperature error The pedelec is outside the permitted temperature range	<ol style="list-style-type: none"> <li>1 Switch off the system to cool the motor and battery down or warm them to the permitted temperature range.</li> <li>2 Re-start the system.</li> <li>3 Contact your specialist dealer if the problem persists.</li> </ol>
605	Temperature error during the charging process	<ol style="list-style-type: none"> <li>1 Disconnect charger from battery.</li> <li>2 Leave battery to cool down.</li> <li>3 Contact your specialist dealer if the problem persists.</li> </ol>
606	External fault	<ol style="list-style-type: none"> <li>1 Check the cabling.</li> <li>2 Re-start the system.</li> <li>3 Contact your specialist dealer if the problem persists.</li> </ol>
610	Voltage error	<ol style="list-style-type: none"> <li>1 Re-start the system.</li> <li>2 Contact your specialist dealer if the problem persists.</li> </ol>
620	Charger error	<ol style="list-style-type: none"> <li>1 Replace charger.</li> <li>2 Contact your specialist dealer if the problem persists.</li> </ol>
640	Internal fault	<ol style="list-style-type: none"> <li>1 Re-start the system.</li> <li>2 Contact your specialist dealer if the problem persists.</li> </ol>
655	Multiple battery error	<ol style="list-style-type: none"> <li>1 Switch off system.</li> <li>2 Remove the battery.</li> <li>3 Re-insert battery.</li> <li>4 Re-start the system.</li> <li>5 Contact your specialist dealer if the problem persists.</li> </ol>
656	Software version error	<ul style="list-style-type: none"> <li>▶ Contact your specialist dealer to install a software update.</li> </ul>
7xx	Gear error	<ul style="list-style-type: none"> <li>▶ Please observe the gear manufacturer's operating instructions.</li> </ul>
800	Internal ABS error	<ul style="list-style-type: none"> <li>▶ Contact your specialist dealer.</li> </ul>
810	Implausible signals from the wheel speed sensor	<ul style="list-style-type: none"> <li>▶ Contact your specialist dealer.</li> </ul>
820	Error in the line to the front wheel speed sensor	<ul style="list-style-type: none"> <li>▶ Contact your specialist dealer.</li> </ul>

**Table 22: List of display screen error messages**

**Table 22: List of display screen error messages**





Code	Description	Method of resolution
821 ... 826	Implausible signals from the front wheel speed sensor. It is defective or incorrectly installed; significantly different tyre diameter between the front wheel and rear wheel; extreme riding, such as riding on the rear wheel only	<ol style="list-style-type: none"> <li>1 Re-start the system.</li> <li>2 Take a test ride of at least two minutes. The ABS indicator lamp must go out.</li> <li>3 Contact your specialist dealer if the problem persists.</li> </ol>
830	Error in the line to the rear wheel speed sensor	▶ Contact your specialist dealer.
831 833 ... 835	Implausible signals from the rear wheel speed sensor. Sensor disc may be missing. It is defective or incorrectly installed; significantly different tyre diameter between the front wheel and rear wheel; extreme riding situation, such as riding on the rear wheel only	<ol style="list-style-type: none"> <li>1 Re-start the system.</li> <li>2 Take a test ride of at least two minutes. The ABS indicator lamp must go out.</li> <li>3 Contact your specialist dealer if the problem persists.</li> </ol>
840	Internal ABS error	▶ Contact your specialist dealer.
850	Internal ABS error	▶ Contact your specialist dealer.
860, 861	Error in the power supply	<ol style="list-style-type: none"> <li>1 Re-start the system.</li> <li>2 Contact your specialist dealer if the problem persists.</li> </ol>
870, 871, 880 883... 885	Communication error	<ol style="list-style-type: none"> <li>1 Re-start the system.</li> <li>2 Contact your specialist dealer if the problem persists.</li> </ol>
889	Internal ABS error	▶ Contact your specialist dealer.
890	ABS indicator lamp is defective or missing; ABS may not be functioning	▶ Contact your specialist dealer.
No Indicator	Internal display error	▶ Re-start the drive system by switching it on and off.

**Table 22: List of display screen error messages**

### 6.3.2 Rechargeable battery

The battery is protected against deep discharge, overcharging, overheating and short circuits by Electronic Cell Protection (ECP). In the event of a hazard, a protective circuit switches the battery off automatically.

If a fault is detected in the battery, the LEDs flash on the battery level indicator.

Description	Method of resolution
Code: 	<ol style="list-style-type: none"> <li>1 Disconnect charger from battery.</li> <li>2 Leave battery to cool down.</li> <li>3 Contact your specialist dealer if the problem persists.</li> </ol>
If the battery is outside its charging temperature range, three LEDs will flash on the battery level indicator.	
Code: 	▶ Contact your specialist dealer.
If a fault is detected in the battery, two LEDs flash on the battery level indicator.	
Code: 	▶ Contact your specialist dealer.
No LEDs will flash if the charger is defective and will not charge. One or more LEDs will light up permanently, depending on the battery level.	
Code: 	<ol style="list-style-type: none"> <li>1 Check all plug connections.</li> <li>2 Check the contacts on the battery for dirt. Clean the contacts carefully if needed.</li> <li>3 Contact your specialist dealer if the problem persists.</li> </ol>
No LEDs will light up if there is no power.	

**Table 23: List of battery error messages**

## 6.4 Instruction and customer service

Your supplying specialist dealer will provide customer service. Contact details can be found on the pedelec pass for these operating instructions. The specialist dealer will explain all the pedelec functions to you in person, this being when the specialist dealer hands over the pedelec at the latest. These operating instructions are provided to you with every pedelec, so that you can consult them at a later stage.

Your specialist dealer will also be happy to assist you in the future whether you require maintenance, conversion or repair.

## 6.5 Adjusting the pedelec



### Crash caused by incorrectly adjusted torques

If a screw is fastened too tightly, it may break. If a screw is not fastened enough, it may loosen. This will cause a crash with injuries.

- ▶ Always observe the indicated torques on the screw or in the *operating instructions*.

Only a correctly adjusted pedelec will guarantee the desired ride comfort and health-promoting activity. Therefore adjust the *saddle*, the *handlebars* and the *suspension* to your body and your preferred riding style before the first ride.

### 6.5.1 Adjusting the saddle

#### 6.5.1.1 Adjusting the saddle tilt

The saddle tilt must be adjusted to the seat height, the saddle and handlebar position, and the saddle shape to ensure an optimum fit. The seating position can be optimised in this way if needed. First adjust the handlebars, then the saddle.

- ▶ Adjust the saddle tilt to horizontal.

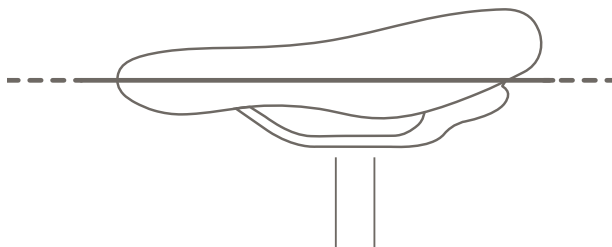

Figure 19: Horizontal saddle tilt

#### 6.5.1.2 Determining the seat height

- ✓ To adjust the seat height safely, either
  - push the bike near to a wall, so that the rider can lean on the wall to support themselves or
  - ask another person to hold the pedelec.

1 Climb onto the bicycle.

2 Place your heel on the pedal and extend your leg, so that the pedal is at the lowest crank rotation point.

- ⇒ The rider sits straight on the saddle if the seat is at an optimum height. If this is not the case, adjust the length of the seat post to your needs.

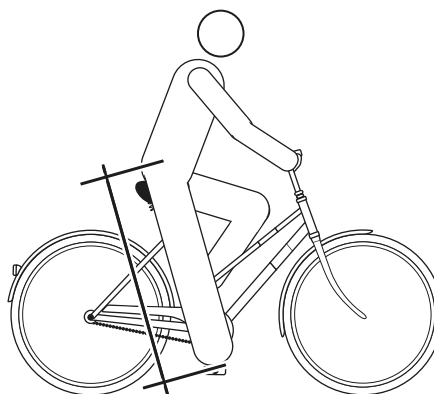

Figure 20: Optimal saddle height

### 6.5.1.3 Adjusting the seat height with quick release

- 1 Open the quick release on the seat post to change the seat height (1). To do so, push the clamping lever away from the seat post (3).

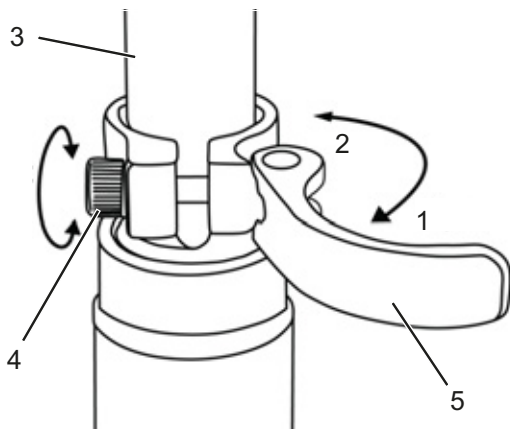

Figure 21: Opening the seat post quick release

- 2 Set the seat post to the required height.



#### Crash caused by an excessively high seat post setting

A seat post which is set too high will cause the seat post or the frame to break. This will cause a crash with injuries.

- ▶ Do not pull the seat post out of the frame beyond the minimum insertion depth marking.

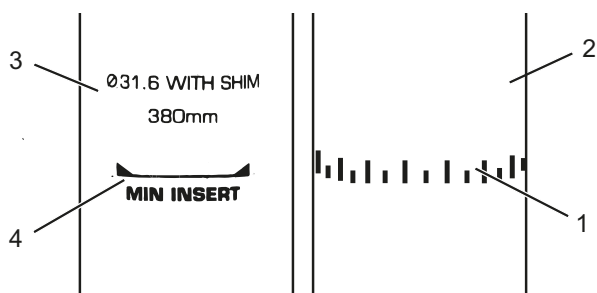

Figure 22: Detailed view of the seat post – examples of the minimum insertion depth marking

- 3 To close it, push the seat post clamping lever as far as it will go into the seat post (2).
- 4 Check the clamping force of quick releases.

### 6.5.1.4 Adjusting the seat position

The saddle can be shifted on the saddle frame. The right horizontal position ensures an optimal leverage position for legs. This prevents knee pain and painful incorrect pelvis positions. If you have displaced the saddle more than 10 mm, you need to adjust the saddle height again since both settings affect one another.

- ✓ To adjust the seat position safely, either push the pedelec near to a wall, so that you can lean on the wall to support yourself or ask another person to hold the pedelec for you.

- 1 Climb onto the bicycle.
- 2 Place the pedals into the vertical position with your feet.

The rider is sitting in the optimal sitting position if the perpendicular line from the kneecap runs through the pedal axle.

- 3.1 If the perpendicular line crosses behind the pedal, bring the saddle further forward.
- 3.2 If the perpendicular line crosses in front of the pedal, bring the saddle further back.
- 4 Move the saddle within its permitted displacement range only (marked on the saddle stay).

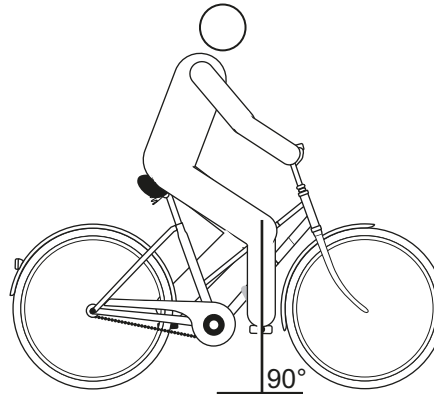

Figure 23: Knee cap perpendicular line

- ✓ The handlebar settings must only be adjusted while the bicycle is stationary.
- ▶ Unfasten and adjust the designated screw connections, and clamp them with the maximum tightening torque for the clamping screws of the handlebars.

## 6.5.2 Adjusting the handlebars

### CAUTION

#### Crash caused by incorrectly set clamping force

Excessively high clamping force will damage the quick release and cause it to lose its function. Insufficient clamping force will result in unfavourable transmission of force. This can cause components to break. This will cause a crash with injuries.

- ▶ Never fasten a quick release using a tool (e.g. hammer or pliers).
- ▶ Only use the clamping lever with the specified set clamping force.

## 6.5.3 Adjusting the stem

### CAUTION

#### Crash caused by loose stem

Incorrectly fastened screws may come loose due to impact. The stem may no longer be firmly fixed in its position as a result. This will cause a crash with injuries.

- ▶ Check the handlebars and the quick release system are firmly in position after the first two hours of riding.

### 6.5.3.1 Adjusting the height of the handlebars

- 1 Open the stem clamping lever.

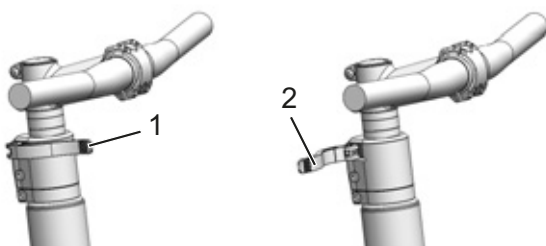

Figure 24: Open (2) and closed (1) stem clamping lever; All Up used as an example

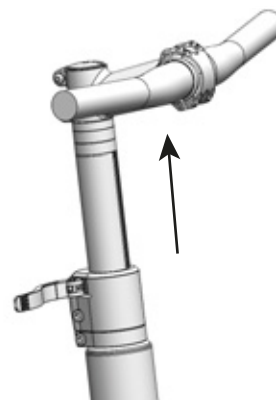

Figure 25: Pulling the locking lever upwards; All Up used as an example

- 2 Pull out the handlebars to the required height. Observe minimum insertion depth.
- 3 Close the stem clamping lever.

### 6.5.3.2 Adjusting the quick release clamping force

- ▶ If the *handlebar clamping lever* stops before reaching its end position, unscrew the *knurled nut*.
- ▶ Tighten the *knurled nut* on the seat post if the *seat post clamping lever's* clamping force is not effective enough.
- ▶ If you are unable to set the clamping force, the specialist dealer will need to check the quick release.

## 6.5.4 Retracting the brake linings

Disc brakes require wearing-in time. The braking force increases over time. You therefore need to be aware that the braking force may increase during the wearing-in period. The same happens after brake pads or discs are replaced.

- 1 Accelerate pedelec to about 25 km/h.
  - 2 Brake pedelec until it comes to a halt.
  - 3 Repeat process 30–50 times.
- ⇒ The disc brake is retracted and provides optimal braking power.



## 6.5.5 Adjusting the Suntour fork

Only applies to pedelecs with this equipment



### Crash caused by incorrectly set suspension

If the suspension is set incorrectly, the fork may become damaged, meaning problems may occur when steering. This will cause a crash with injuries.

- ▶ Never ride the bicycle without air in the air suspension fork.
- ▶ Never use the pedelec without adjusting the suspension fork to the rider's weight.

### Notice

Settings on the chassis change riding performance significantly. You need to get used to the bicycle and break it in to prevent accidents.

The adjustment shown here represents a basic setting. The rider should change the basic setting to suit the surface and his/her preferences.

- ▶ It is advisable to make a note of the basic setting. This way, it can be used as the starting point for subsequent, optimised settings and to safeguard against unintentional changes.

### 6.5.5.1 Adjusting the negative deflection

*Negative deflection* depends on the rider's weight and sitting position. The recommended negative deflection is between 15% (hard) and 30% (soft) of the *total fork deflection*.

### 6.5.5.2 Adjusting the steel suspension fork negative deflection

Only applies to pedelecs with this equipment

You can adjust the tensioning in the fork spring to the rider's weight and their preferred riding style. This reduces the negative deflection in the fork.



Figure 26: Negative deflection setting wheel on the suspension fork crown

- 1 You will find the **negative deflection setting wheel** beneath the plastic cover on the **crown**. Remove the plastic cover. Turn the **negative deflection setting wheel** in a clockwise direction to increase the spring pre-tensioning. Turn the **negative deflection setting wheel** in an anti-clockwise direction to decrease the spring pre-tensioning.
- ⇒ You will have made the ideal setting if the shock absorber deflects 3 mm when bearing the rider's weight.
- 2 Replace the plastic cover on the **crown** after making the setting.

## 6.6 Accessories

We recommend a parking stand into which either the front wheel or rear wheel can be inserted securely for pedelecs which do not have a kickstand. The following accessories are recommended:

Description	Article number
Protective cover for electrical components	080-41000 ff
Panniers, system component*	080-40946
Rear wheel basket, system component*	051-20603
Bicycle box, system component*	080-40947
Parking stand universal stand	XX-TWO14B

**Table 24: Accessories**

\*System components are matched to the pannier rack and provide sufficient stability due to special transmission of force.

\*\*System components are matched to the drive system.

### 6.6.1 Child seat

#### WARNING

##### Crash caused by incorrect child seat

The pannier rack and down tube are unsuitable for mounting child seats and may break. Such an incorrect position may cause a crash with serious injuries for the rider and the child.

- ▶ Never attach a child seat to the saddle, handlebars or down tube.

#### CAUTION

##### Crash caused by improper handling

When using child seats, the pedelec's handling characteristics and stability change considerably. This can cause a loss of control, a crash and injuries.

- ▶ You should practice how to use the child seat safely before using the pedelec in public spaces.

#### CAUTION

##### Risk of crushing due to exposed springs

The child may crush his/her fingers on exposed springs or open mechanical parts of the saddle or the seat post.

- ▶ Never install saddles with exposed springs if a child seat is being used.
- ▶ Never install seat posts with suspension with open mechanical parts or exposed springs if a child seat is being used.

#### Notice

- ▶ Observe the legal regulations on the use of child seats.
- ▶ Observe the operating and safety instructions for the child seat system.
- ▶ Never exceed the maximum permitted total weight.

The specialist dealer will advise you on choosing a suitable child seat system for the child and the pedelec.

The specialist dealer must install the child seat the first time to ensure that it is safely fitted.

When installing a child seat, the specialist dealer makes sure that the seat and the fastening mechanism for the seat are suitable for the pedelec and that all components are installed and firmly fastened. They will also ensure that shift cables, brake cables, hydraulic lines and electrical cables are adjusted as necessary, the rider has optimum freedom of movement and the pedelec's maximum permitted total weight is complied with.

The specialist dealer will provide instruction on how to handle the pedelec and the child seat.

## 6.6.2 Trailer



### Crash caused by brake failure

The braking distance may be longer if the trailer is carrying excessive load. The long braking distance can cause a crash or an accident and injuries.

- ▶ Never exceed the specified trailer load.

### Notice

- ▶ The operating and safety instructions for the trailer system must be observed.
- ▶ The statutory regulations on the use of bicycle trailers must be observed.
- ▶ Only use type-approved coupling systems.

A pedelec which is approved for towing a trailer will bear an appropriate adhesive label. You may only use trailers with a tongue load and weight which do not exceed the permitted values.

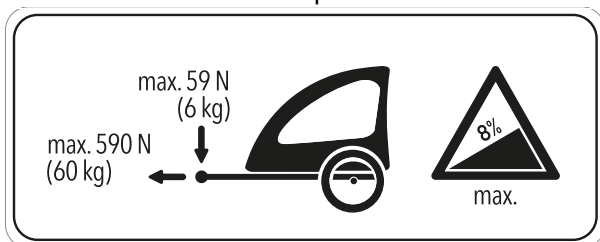

Figure 27: Trailer sign

The specialist dealer will advise on choosing a suitable trailer system for the pedelec. The specialist dealer must install the trailer the first time to ensure that it is safely fitted.

## 6.6.3 Pannier rack

The specialist dealer will advise on choosing a suitable pannier rack.

The specialist dealer must install the pannier rack the first time to ensure that it is safely fitted.

When installing a pannier rack, the specialist dealer makes sure that the fastening mechanism is suitable for the pedelec and that all components are installed and firmly fastened. They will also ensure that shift cables, brake cables, hydraulic lines and electrical cables are adjusted as necessary, the rider has optimum freedom of movement and the pedelec's maximum permitted total weight is not exceeded.

The specialist dealer will provide instruction on how to handle the pedelec and the pannier rack.

## 6.7 Check list before each ride

► Check the pedelec before each ride.

⇒ Take the pedelec out of service if you spot any anomalies.

<input type="checkbox"/>	Check that the pedelec is complete.
<input type="checkbox"/>	Check the battery is firmly in place.
<input type="checkbox"/>	Check that components such as the lighting, reflector and brake are sufficiently clean.
<input type="checkbox"/>	You must check that the mudguards, the pannier rack and the chain guard are securely installed.
<input type="checkbox"/>	Check that the front and rear wheels run true. This is particularly important if the pedelec been transported or secured with a lock.
<input type="checkbox"/>	Check the valves and the tyre pressure. Adjust as necessary before each ride.
<input type="checkbox"/>	If the bicycle has a hydraulic rim brake, check whether the locking levers are fully closed in their final positions.
<input type="checkbox"/>	Check the front and rear wheel brakes to make sure that they are working properly. To do so, push the brake levers while stationary to check whether resistance is generated in the usual brake lever position. The brake must not lose any brake fluid.
<input type="checkbox"/>	Check that the riding light is working.
<input type="checkbox"/>	Check for unusual noises, vibrations, smells, staining, deformation, cracks, scores, abrasion and wear. This indicates material fatigue.
<input type="checkbox"/>	Inspect suspension system for cracks, dents, bumps, parts or leaking oil. Look at concealed sections on the pedelec's lower surface.
<input type="checkbox"/>	If quick releases are used check them to make sure that they are fully closed in their end position.
<input type="checkbox"/>	Be alert to any unusual operating sensations when braking, pedalling or steering.

## 6.8 Using the kickstand

### 6.8.1 Raising the kickstand

- ▶ Use your foot to raise the kickstand completely before setting off.

## 6.9 Using the pannier rack



### Crash caused by loaded pannier rack

The pedelec is handled differently with a loaded *pannier rack*, in particular when the rider needs to steer and brake. This can lead to a loss of control. This may cause a crash with injuries.

- ▶ You should practice how to use a loaded *pannier rack* safely before using the pedelec in public spaces.

### Crushing the fingers in the spring flap

The spring flap on the *pannier rack* operates with a high clamping force. There is a risk of crushing the fingers.

- ▶ Never allow the spring flap to snap shut in an uncontrolled manner.

Be careful where you position your fingers when closing the spring flap.



### Crash caused by unsecured baggage

Loose or unsecured objects on the *pannier rack*, e.g. belts, may become caught in the rear wheel. This may cause a crash with injuries.

Objects which are fastened to the pannier rack may cover the *reflectors* and the *riding light*. Other users may not see the pedelec on public roads as a result. This may cause a crash with injuries.

- ▶ Secure any objects which are attached to the *pannier rack* sufficiently.
- ▶ Objects fastened to the *pannier rack* must never cover the *reflectors*, the *headlight* or the *rear light*.

- ▶ Distribute the baggage as evenly as possible between the left- and right-hand side.
- ▶ We recommend the use of panniers and baggage baskets.

The maximum load bearing capacity is indicated on the *pannier rack*.

- ▶ Never exceed the maximum permitted *total weight* when packing the pannier.
- ▶ Never exceed the maximum load bearing capacity of the pannier rack.
- ▶ Never modify the *pannier rack*.

## 6.10 Using the saddle

- ▶ Do not wear studded jeans as these can damage the saddle covering.
- ▶ Wear dark clothes for your first few rides as new leather saddles can stain clothing.
- ▶ Protect the saddle with a saddle cover if you park the pedelec outside.

## 6.11 Rechargeable battery

- ✓ Switch off the battery and the drive system before removing or inserting the battery.

### 6.11.1 Frame battery

Only applies to pedelecs with this equipment

#### 6.11.1.1 Removing the frame battery

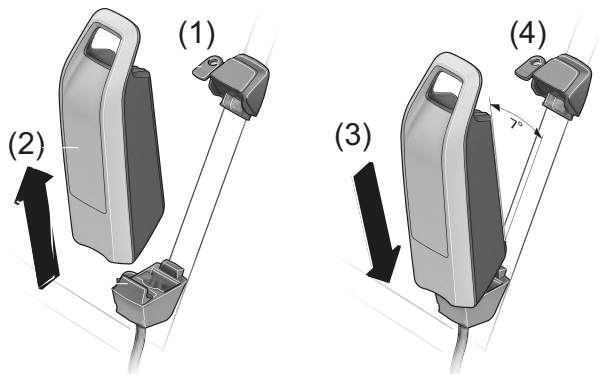

Figure 28: Removing and inserting the frame battery

- 1 Open battery lock with battery key (see (1)).
- 2 Tip the battery out of the top section of the **frame battery mount**.
- 3 Pull battery from the **frame battery mount** (see (2)).

#### 6.11.1.2 Inserting the frame battery

- 1 Place the battery on the contacts in the lower section of the **frame battery mount** (see (3)).
- 2 Remove the battery key from the battery lock (see (4)).
- 3 Tip the battery into the top section of the **frame battery mount** until it will go no further.
  - ⇒ There is an audible clicking noise.
- 4 Check the battery to make sure it is firmly in place.

## 6.11.2 Charging the battery

**CAUTION**

### Fire caused by overheated charger

The charger heats up when charging the battery. In case of insufficient cooling, this can result in fire or burns to the hands.

- ▶ Never use the charger on a highly flammable surface (e.g. paper, carpet etc.).
- ▶ Never cover the charger during the charging process.
- ▶ Never leave battery unattended during charging.

### Electric shock caused by penetration by water

If water penetrates into the charger, there is a risk of electric shock.

- ▶ Never charge the battery outdoors.

### Electric shock in case of damage

Damaged chargers, cables and plug connectors increase the risk of electric shock.

- ▶ Check the charger, cable and plug connector before each use. Never use a damaged charger.

## Notice

If an error occurs during the charging process, a system message is displayed.

- ▶ Remove the charger and battery from operation immediately and follow the instructions.

- ✓ The ambient temperature during the charging process must be within the range from 0 °C to 40 °C.
- ✓ The battery can remain on the pedelec or can be removed for charging.
- ✓ Interrupting the charging process does not damage the battery.

- 1 Remove the cable connection cover if necessary.
- 2 Connect the mains plug of the charger to a normal domestic, grounded socket.

<b>Connection data</b>	230 V, 50 Hz
------------------------	--------------

## Notice

- ▶ Check that mains voltage! The power source voltage must match the voltage indicated on the charger nameplate. Chargers labelled 230 V may be operated at 220 V.
- 
- 3 Connect the charging cable to the battery's charging port.
    - ⇒ The charging process starts automatically.
    - ⇒ The battery level indicator shows the charge level during charging. When the drive system is switched on, the *display screen* shows the charging process.
    - ⇒ The charging process is complete when the LEDs on the operating status and battery level indicator go out.
  - 4 Once charging is complete, disconnect the battery from the charger.
  - 5 Disconnect the charger from the mains.

## 6.12 Electric drive system

### 6.12.1 Switching on the electric drive system



#### Crash caused by lack of readiness for braking

When it is switched on, the drive system can be activated by the application of force on the pedals. There is a risk of a crash if the drive is activated unintentionally, and the brake is not reached.

- ▶ Never start the electric drive system, or switch it off immediately, if the brake cannot be reached safely and reliably.

- ✓ A sufficiently charged battery has been inserted into the pedelec.
- ✓ The battery is firmly positioned. The battery key has been removed.

There are three options for switching on the drive system.

#### On-Off button (battery)

- ▶ Press the **On-Off button (battery)** briefly.

#### On-Off button (display)

- ▶ Press the **On-Off button (display)** briefly.

#### Switched-on display

- ▶ If the display is already switched on when it is inserted into its mount, the electric drive system is switched on automatically.
- ⇒ After switching on, a speed of 0 KM/H is displayed on the *display*. If it is not, check whether the *display screen* is fully engaged into position.
- ⇒ If the drive system is switched on, the drive is activated as soon as the pedals are moved with sufficient force (except if in push assist mode or the level of assistance is "OFF").
- ⇒ The motor power is determined by the level of assistance set on the display.
- ⇒ As soon as the system has been activated, ACTIVE LINE/PERFORMANCE LINE appears briefly on the *display*.

### 6.12.2 Switching off the drive system

As soon as you stop pushing the pedals in normal mode or reach a speed of 25 km/h, the drive system switches off the assistance system. The assistance system starts up again if you push the pedals and your speed is less than 25 km/h.

The system switches off automatically ten minutes after the last command. There are three options for switching off the drive system manually.

#### On-Off button (display)

- ▶ Press the **On-Off button (display)** briefly.

#### On-Off button (battery)

- ▶ Press the **On-Off button (battery)**.

#### Removing the display

- ▶ Remove the *display* from the mount.
- ⇒ The LEDs on the operating status and battery level indicator go out.



## 6.13 Display



### Crash caused by distraction

A lack of concentration while riding increases the risk of an accident. This may cause a crash with serious injuries.

- ▶ Never allow yourself to be distracted by the display.
- ▶ Stop bicycle if you want to make inputs on the display other than a change in level of assistance. Only enter data when the bicycle is stationary.

### Notice

- ▶ Never use the display as a handle. The display may become irreparably damaged if you use it to lift the pedelec.
- ▶ If you do not use your pedelec for several weeks, remove the batteries from the display.
- ▶ Adjust the display screen brightness in such a way that you can see text and icons sufficiently clearly.

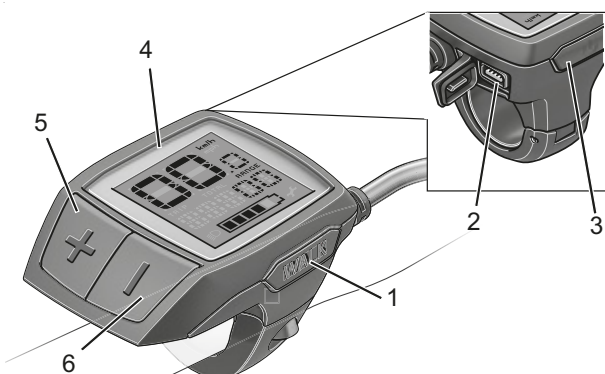

Figure 29: Display overview

Symbol	Designation
1	<b>WALK</b> Push assist button
2	USB port
3	 On-Off button (display)
4	Indicator
5	<b>+</b> Plus button
6	<b>-</b> Minus button

Table 25: Overview of the control panel with display

### 6.13.1 Overview of actions on the display screen





Action	Button	Duration
Switching on the display		Brief
Switching off the display		Brief (< 1 s)
Using the push assist system	<b>WALK</b> <b>+</b>	1. Brief (< 1 s) 2. Any
Increase assistance	<b>+</b>	Brief (< 1 s)
Reduce assistance	<b>-</b>	Brief (< 1 s)
TRIP/TOTAL/RANGE screen, assistance modes	<b>-</b>	Medium (1- 2.5 s)
Switch on riding light	<b>+</b>	Medium (1- 2.5 s)
Switch off riding light	<b>+</b>	Long (> 2.5 s)
Reset journey distance	<b>- +</b>	Long (> 2.5 s)
Switch from kilometres to miles		1. Hold 2. Brief (< 1 s)
Get versions	<b>- +</b> 	1. Hold 2. Brief (< 1 s)
Set display screen brightness	 <b>- or +</b>	1. Hold 2. Brief (< 1 s) 3. Brief (< 1 s)

Table 26: Overview of actions on the display screen

### 6.13.2 Switching on the display

- ▶ Press the **On-Off button (display)** briefly.
- ⇒ The electric drive system is switched on.

### 6.13.3 Switching off the display

- ▶ Press the **On-Off button (display)** briefly.
- ⇒ The electric drive system is switched off.

## 6.14 Using the push assist system



### Injury from pedals or wheels

The pedals and the drive wheel turn when the push assist system is used. There is a risk of injury if the pedelec wheels are not in contact with the ground when the push assist system is used (e.g. when carrying the pedelec up stairs or when placing it on a bicycle rack).

- ▶ Only use the push assist mode when pushing the pedelec.
- ▶ You must steer the pedelec securely with both hands when using push assist.
- ▶ Allow for enough freedom of movement for the pedals.

The push assist helps the rider to push the pedelec. The speed can be a maximum of 6 km/h in this case.

The push assist cannot be activated at the OFF assistance level.

- ✓ The tractive power of the push assist and its speed can be influenced by the selection of gear. To spare the drive, first gear is recommended for travelling uphill.
  - ✓ The level of assistance OFF must not be selected.
- 1 Press the **push assist button** briefly (< 1 s) to activate the push assist.
  - 2 Press and hold down the **plus button** within 3 seconds to switch on push assist.
  - 3 Release the **plus button** to switch off push assist.
- ⇒ The push assist system switches off automatically as soon as the pedelec wheels are blocked or the speed exceeds 6 km.

### 6.14.1 Using the riding light

- ✓ The drive system needs to be already switched on to turn on the *riding light*.
- ▶ Push the **plus button** momentarily (1 to 2.5 s).
  - ⇒ The *riding light* is switched on. The *riding light symbol* is displayed.
- ▶ Push the **plus button** for a long time (> 2.5 s).
  - ⇒ The riding light is switched off. The *riding light symbol* is not displayed.

### 6.14.2 Selecting the level of assistance

- ▶ Press the **plus button** briefly (< 1 s) to increase the level of assistance.
- ▶ Press the **minus button** briefly (< 1 s) to reduce the level of assistance.

### 6.14.3 Journey information

The displayed *journey information* can be changed and partially reset.

#### 6.14.3.1 Switching the journey information

- ▶ Push the **minus button** momentarily (1 to 2.5 s).
  - ⇒ The journey information trip distance (TRIP), total distance travelled (TOTAL), range (RANGE), and support modes used are shown on the display screen.

#### 6.14.3.2 Resetting the trip distance

- 1 Select the item of journey information TRIP.
- 2 Push both the **plus button** and the **minus button** at the same time for a long time (> 2.5 s).
  - ⇒ RESET is shown on the display screen.
- 3 If you continue to jiggle the **plus** and **minus buttons** at the same time, the trip distance will be reset to 0.

### 6.14.3.3 Resetting the range

- 1 Select the item of journey information **RANGE**.
- 2 Push both the **plus button** and the **minus button** at the same time for a long time (> 2.5 s).
  - ⇒ RESET is shown on the display screen.
- 3 If you continue to jiggle the **plus** and **minus buttons** at the same time, the range will be reset to 0.

### 6.14.3.4 Changing the tachometer unit

You can change the displayed values from kilometres to miles.

- 1 Keep the **minus button** pressed down.
- 2 Press the **On-Off button (display)** briefly (< 1 s).
  - ⇒ All values are changed from kilometres to miles.

### 6.14.3.5 Displaying versions and type numbers

You can retrieve the sub-system versions and their type part numbers for maintenance purposes if the sub-systems provide this type of information (depends on the sub-system).

- ✓ The drive system must be switched off.
- 1 Keep the **plus** and **minus buttons** pressed down at the same time.
  - 2 Press the **On-Off button (display)** briefly (< 1 s).
    - ⇒ The version or type number will be displayed as moving text.

### 6.14.3.6 Set display screen brightness

- ✓ The display must be switched off.
- 1 Keep the **plus** and **minus buttons** pressed down at the same time.
  - 2 Press the **On-Off button (display)** briefly (< 1 s).
  - 3 Use the **plus button** or **minus button** to adjust the display screen brightness in such a way that you can see text and icons sufficiently clearly.

### 6.14.4 Using the USB port

#### Notice

The USB port is reserved to connect diagnostics systems. The USB port must be kept completely closed with the protective cap at all times.

Any moisture penetrating through the USB port may trigger a short circuit in the display.

- ▶ Regularly check the position of the rubber cover on the USB port and adjust it as necessary.

### 6.14.5 Replacing the battery

- ✓ When the on-board computer indicates LOW BAT on the screen, the battery is flat and must be replaced.

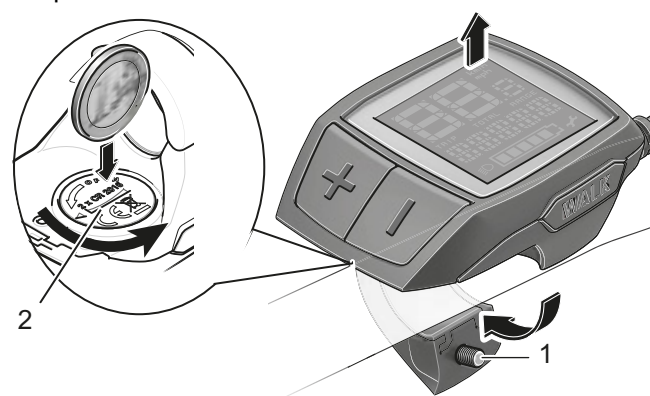

Figure 30: Display with attachment screw (1) and battery compartment cover (2)

- 1 Remove the display from the handlebars by unfastening the display attachment screw (1).
- 2 Use a suitable coin to open the battery compartment cover (2).
- 3 Remove the used battery.
- 4 Insert a new CR 2016 display battery. You can obtain the batteries recommended by Bosch from your specialist dealer. Ensure correct polarity when inserting the display battery.
- 5 Close the battery compartment again and fasten the on-board computer to the handlebars with the attachment screw (1).

## 6.15 Brake

### **WARNING**

#### **Crash caused by brake failure**

Oil or lubricant on the brake disc in a disc brake or on the rim of a rim brake can cause the brake to fail completely. This may cause a crash with serious injuries.

- ▶ Never allow oil or lubricant to come into contact with the brake disc or brake linings or on the rim of a rim brake.
- ▶ If the brake linings have come into contact with oil or lubricant, contact a dealer or a workshop to have the components cleaned or replaced.

If the brakes are applied continuously for a long time (e.g. while riding downhill for a long time), the fluid in the brake system may heat up. This may create a vapour bubble. This will cause air bubbles or any water contained in the brake system to expand. This may suddenly make the lever travel wider. This may cause a crash with serious injuries.

- ▶ Release the brake regularly when riding downhill for a longer period of time.

#### **Amputation due to rotating brake disc**

The brake disc in disc brakes is so sharp that it can cause serious injuries to fingers if they are inserted into the brake disc openings.

- ▶ Always keep fingers well away from the rotating brake discs.

### **CAUTION**

#### **Burns caused by heated brake**

The brakes may become very hot during operation. There is a risk of burns or fire in case of contact.

- ▶ Never touch the components of the brake directly after the ride.

### **CAUTION**

#### **Crash caused by wet conditions**

The tyres may slip on wet roads. In wet conditions you must also expect a longer braking distance. The braking sensation differs from the usual sensation. This can cause loss of control or a crash, which may result in injuries.

- ▶ Ride slowly and brake in good time.

#### **Crash caused by incorrect use**

Handling the brake improperly can lead to loss of control or crashes, which may result in injuries.

- ▶ Shift your body weight backwards and down as far as possible.
- ▶ Practice braking and emergency braking before using the pedelec in public spaces.
- ▶ Never use the pedelec if you can feel no resistance when you grip the brake handle. Consult a specialist dealer.

#### **Crash after cleaning or storage**

The brake system is not designed for use on a pedelec which is placed on its side or turned upside down. The brake may not function correctly as a result. This can cause a crash, which may result in injuries.

- ▶ If the pedelec is placed on its side or turned upside down, apply the brake a couple of times before setting off to ensure that it works as normal.
- ▶ Never use the pedelec if the brake does not work properly. Consult a specialist dealer.

The drive force of the motor is shut off during the ride as soon as the rider no longer pedals. The drive system does not switch off when braking.

- ▶ In order to achieve optimum braking results, do not pedal while braking.

### 6.15.1 Using the brake lever

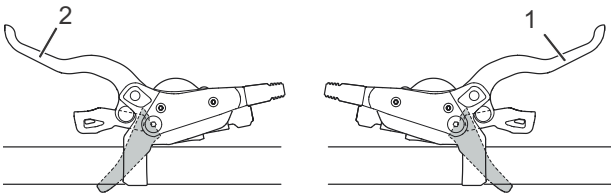

Figure 31: Front (2) and rear (1) brake lever – Shimano brake used as an example

- ▶ Push the left-hand *brake lever* to apply the *front wheel brake*.
- ▶ Push the right-hand *brake lever* to apply the *rear wheel brake*.

## 6.16 Suspension and damping

### 6.16.1 Adjusting the compression in the Suntour fork

Only applies to pedelecs with this equipment

The compression adjuster makes it possible to make quick adjustments to the suspension behaviour of the fork to suit changes in terrain. It is intended for adjustments made during the ride.



Figure 32: Suntour compression adjuster with OPEN (1) and LOCK (2) positions

- ▶ Compression damping is lowest in the OPEN position, making the fork feel softer.
- ▶ Use the lock position if you want the fork to feel stiffer and you are riding on soft ground.
- ▶ The positions between OPEN and LOCK provide fine adjustment of compression damping.

We recommend setting the compression adjuster to the OPEN position first.

The compression damper controls the speed at which the rear frame damper deflects during slow impact, such as smaller impacts or when the rider goes round a corner or shifts their weight. The compression damper improves control and efficiency.

If the compression damper is set too high, suspension is too hard when exposed to impacts. The damper lever is used to set the compression damper.

- ▶ Turn the setting wheel in a clockwise direction (+) to decrease the deflection speed.

## 6.17 Gear shift

The selection of the appropriate gear is a prerequisite for a physically comfortable ride and making sure that the electric drive system functions properly. The ideal pedalling frequency is between 70 and 80 revolutions per minute.

- ▶ Stop pedalling briefly when changing gears. This makes it easier to switch gears and reduces wear on the drivetrain.

### 6.17.1 Using the derailleur gears

Only applies to pedelecs with this equipment

The speed and range can be increased while applying the same force if you select the right gear. Use the derailleur gears.

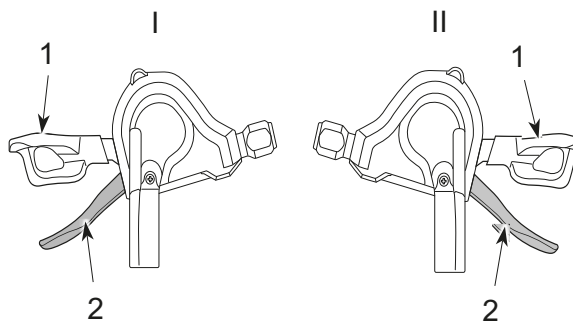

Figure 33: Down shifter (1) and up shifter (2) on the left (I) and right (II) gear shift

- ▶ Select the appropriate gear with the *shifter*.
- ⇒ The gear shift switches the gear.
- ⇒ The shifter returns to its original position.
- ▶ Clean and lubricate the rear derailleur if gear changes block.

## 6.18 Parking the pedelec

### Notice

Heat or direct sunlight can cause the *tyre pressure* to increase above the permitted maximum pressure. This can destroy the *tyres*.

- ▶ Never park the pedelec in the sun.
- ▶ On hot days, regularly check the *tyre pressure* and adjust it as necessary.

---

Moisture penetrating at low temperatures may impair individual functions due to the open structural design.

- ▶ Always keep the pedelec dry and free from frost.
- ▶ If the pedelec is to be used at temperatures below 3 °C, the specialist dealer must carry out an inspection and prepare it for winter use.

---

The pedelec's force of weight may cause the kickstand to sink into soft ground, possibly causing the pedelec to topple over as a result.

- ▶ The pedelec must be parked on firm, level ground only.

- 
- 1 Switch off the drive system (see Section 6.12.2).
  - 2 After getting off, use your foot to lower the kickstand completely before parking.
  - 3 Park the pedelec carefully and check that it is stable.
  - 4 Cleaning the suspension fork and pedals (see Section 7.1.)
  - 5 Protect the saddle with a saddle cover if you park the pedelec outside.
  - 6 Remove the display (see Section 6.13) and the battery (see Section 6.11.1, 6.11.1.1 or 6.11.1.2) to protect against theft.



## 7 Cleaning and servicing

### Cleaning check list

<input type="checkbox"/>	Clean the pedals	after each ride
<input type="checkbox"/>	Clean the suspension fork and, if necessary, rear frame damper	after each ride
<input type="checkbox"/>	Cleaning the battery	once a month
<input type="checkbox"/>	Chain (mainly tarmacked road)	Every 250–300 km
<input type="checkbox"/>	Basic cleaning and preservation of all components	at least every six months
<input type="checkbox"/>	Clean the charger	at least every six months
<input type="checkbox"/>	Clean and lubricate the height-adjustable seat post	every six months

### Maintenance check list

<input type="checkbox"/>	Check USB rubber cover position	before each ride
<input type="checkbox"/>	Check for tyre wear	once a week
<input type="checkbox"/>	Check for rim wear	once a week
<input type="checkbox"/>	Check tyre pressure	once a week
<input type="checkbox"/>	Check brakes for wear	once a month
<input type="checkbox"/>	Check electrical cables and Bowden cables for damage and ensure they are fully functional	once a month
<input type="checkbox"/>	Check chain tension	once a month
<input type="checkbox"/>	Check tension of the spokes	every three months
<input type="checkbox"/>	Check the gear shift setting	every three months
<input type="checkbox"/>	Check suspension fork and, if necessary, rear frame damper for wear and ensure fully functional	every three months
<input type="checkbox"/>	Check for wear on brake discs	at least every six months



### Crash and falling caused by unintentional activation

There is a risk of injury if the drive system is activated unintentionally.

- ▶ Remove the battery before cleaning.

Servicing measures must be performed regularly. Contact your specialist dealer if you are unsure.

## 7.1 Cleaning after each ride

### Required tools and cleaning agents:

- Cloth
- Air pump
- Brush
- Water
- Dish-washing liquid
- Bucket

### 7.1.1 Cleaning the suspension fork

- ▶ Remove dirt and deposits from the stanchions and deflector seals with a damp cloth.
- ▶ Check the stanchions for dents, scratches, staining or leaking oil.
- ▶ Check the air pressure.
- ▶ Lubricate the dust seals and stanchions.

### 7.1.2 Cleaning the rear frame damper

- ▶ Remove dirt and deposits from the damper body with a damp cloth.
- ▶ Check rear frame damper for dents, scratches, staining or leaking oil.

### 7.1.3 Cleaning the pedals

- ▶ Clean with a brush and soapy water after riding through dirt or rain.
- ⇒ Service the pedals after cleaning.

## 7.2 Basic cleaning



### CAUTION

#### Crash caused by brake failure

The braking effect may be unusually poor temporarily after cleaning, servicing or repairs. This may cause a crash with injuries.

- ▶ Never apply care products or oil to the brake discs or brake linings, or the braking surfaces on the rims.
- ▶ After cleaning, servicing or repair, carry out a few test brake applications.

### Notice

Water may enter the inside of the bearings if you use a steam jet. This dilutes the lubricant inside, the friction increases and, as a result, the bearings are permanently damaged in the long term.

- ▶ Never clean the pedelec with a pressure washer.

Greased parts, such as the seat post, the handlebars or the stem, may no longer be safely and reliably clamped.

- ▶ Never apply grease or oil to clamping sections.

#### Required tools and cleaning agents:

- Cloths
- Sponge
- Air pump
- Brush
- Toothbrush
- Paintbrush
- Watering can
- Bucket
- Water
- Dish-washing liquid
- Degreaser
- Lubricant
- Brake cleaner or spirit

- ✓ Remove battery before basic cleaning.

### 7.2.1 Cleaning the frame

- 1 Soak the entire frame with dish-washing detergent if the dirt is thick and ingrained.
- 2 After leaving it to soak for a short time, remove the dirt and mud with a sponge, brush and toothbrushes.
- 3 Use a watering can or your hand to rinse the frame.
- 4 Service the frame after cleaning.

### 7.2.2 Cleaning the stem

- 1 Clean stem with a cloth and soapy water.
- 2 Service the stem after cleaning.

### 7.2.3 Cleaning the wheel



### WARNING

#### Crash caused by braking hard on rims

A rim can break and block the wheel if you brake hard. This may cause a crash with serious injuries.

Check rim *wear* on a regular basis.

- 1 Check the tyres, rims, spokes and spoke nipples for any damage while cleaning the wheel.
- 2 Use a sponge and a brush to clean the hub and spokes from the inside to the outside.
- 3 Clean the rim with a sponge.

### 7.2.4 Cleaning the drive elements

- 1 Spray the cassette, the chain wheels and the front derailleur with a degreasing agent.
- 2 Clean coarse dirt with a brush after soaking for a short time.
- 3 Wash down all parts with dish-washing detergent and a toothbrush.
- 4 Service the drive elements after cleaning.

### 7.2.5 Cleaning the rear frame damper

[Only applies to pedelecs with this equipment](#)

- ▶ Clean rear frame damper with a cloth and soapy water.

### 7.2.6 Cleaning the chain

#### Notice

- ▶ Never use aggressive (acid-based) cleaners, rust removers or degreasers when cleaning the chain.
- ▶ Never use chain cleaning devices or chain cleaning baths.

- 1 Slightly dampen a brush with dish-washing liquid. Brush both sides of the chain.
- 2 Dampen a cloth with soapy water. Place the cloth on the chain.
- 3 Hold and apply slight pressure while slowly turning the rear wheel, so the chain passes through the cloth.
- 4 If the chain is still dirty afterwards, clean with lubricant.
- 5 Service the chain after cleaning.

### 7.2.7 Cleaning the battery



#### CAUTION

#### Risk of fire and explosion due to penetration by water

The battery is only protected from simple spray water. Penetration by water can cause a short circuit. The battery may self-ignite and explode.

- ▶ Never clean the battery with a pressure washer, water jet or compressed air.
- ▶ Keep contacts dry and clean.
- ▶ Never immerse the battery in water.
- ▶ Never use cleaning agents.
- ▶ Remove the battery from the pedelec before cleaning.

#### Notice

- ▶ Never clean the battery with solvents, such as oil, thinners, alcohol or corrosion protection, or with cleaning agents.
- ▶ Clean the battery electrical connections with a dry cloth or paintbrush only.
- ▶ Wipe off the decorative sides with a damp cloth.

### 7.2.8 Cleaning the display

#### Notice

If water enters into the display screen, it will be permanently damaged.

- ▶ Never immerse the display in water.
- ▶ Never clean with a pressure washer, water jet or compressed air.
- ▶ Never use cleaning agents.
- ▶ Remove the display from the pedelec before cleaning.

- ▶ Carefully clean the display with a soft, damp cloth.

### 7.2.9 Cleaning the motor



#### CAUTION

#### Burns from hot motor

The motor cooler can become extremely hot during use. Touching it may cause burns.

- ▶ Leave the motor to cool before cleaning.

#### Notice

If water penetrates the motor, it will be permanently damaged.

- ▶ Never immerse the motor in water.
- ▶ Never clean with a pressure washer, water jet or compressed air.
- ▶ Never use cleaning agents.
- ▶ Carefully clean the motor with a soft, damp cloth.

## 7.2.10 Cleaning the brake



### Brake failure due to water penetration

The brake seals are unable to withstand high pressures. Damaged brakes can fail and cause an accident with injury.

- ▶ Never clean the pedelec with a pressure washer or compressed air.
  - ▶ Take great care when using a hosepipe. Never point the water jet directly at the seal section.
- 
- ▶ Clean brake and brake discs with a brush, water and dish-washing detergent.
  - ▶ Clean brake discs thoroughly with brake cleaner or spirit.

## 7.3 Servicing

### Required tools and cleaning agents:

- Cloths
- Toothbrushes
- Dish-washing liquid
- Care oil for frames
- Silicone or Teflon oil
- Acid-free lubricating grease
- Fork oil
- Chain oil
- Degreaser
- Spray oil
- Teflon spray

## 7.3.1 Servicing the frame

- ▶ Dry the frame.
- ▶ Spray with care oil.
- ▶ Clean off the care oil again after a short time.

## 7.3.2 Servicing the stem

- ▶ Apply silicone or Teflon oil to the stem shaft tube and the quick release lever pivot point.
- ▶ If you have speedlifter Twist, also apply oil to the unlocking bolt using the groove in the speedlifter body.
- ▶ Apply a little acid-free lubricant grease between the stem quick release lever and the sliding piece to reduce the quick release lever operating force.

## 7.3.3 Servicing the fork

- ▶ Treat the dust seals with fork oil.

## 7.3.4 Servicing the drive elements

- 1 Spray the cassette, the chain wheels and the front derailleur with a degreasing agent.
- 2 Clean coarse dirt with a brush after soaking for a short time.
- 3 Wash down all parts with dish-washing detergent and a toothbrush.
- 4 Treat front and rear derailleur articulated shafts and jockey wheels with Teflon spray.

## 7.3.5 Servicing the pedals

- ▶ Treat pedals with spray oil.

## 7.3.6 Servicing the chain

- ▶ Lubricate the chain thoroughly with chain oil.

## 7.4 Maintenance



### Crash and falling caused by unintentional activation

There is a risk of injury if the drive system is activated unintentionally.

- ▶ Remove the battery before maintenance.

The following maintenance measures must be performed on a regular basis.

### 7.4.1 Wheel



#### Crash caused by braking hard on rims

A rim can break and block the wheel if you brake hard. This may cause a crash with serious injuries.

- ▶ Check rim *wear* on a regular basis.

#### Notice

If the tyre pressure is too low in the tyre, the tyre does not achieve its load bearing capacity. The tyre is not stable and may come off the rim.

If the tyre pressure is too high, the tyre may burst.

- ▶ Check the tyre pressure as per specifications
- ▶ *Adjust the tyre pressure* as necessary.

- 1 Check the *tyres* for wear.
- 2 Check the *tyre pressure*.
- 3 Check the *rims* for wear.

- ⇒ The rims of a rim brake with invisible wear indicator are worn as soon as the wear indicator becomes visible in the area of the rim joint.
  - ⇒ The rims with visible wear indicator are worn as soon as the black, all-round groove on the pad friction surface is no longer visible. We recommend that you also replace the *rims* with every second brake lining replacement.
- 4 Check the tension of the spokes.

### 7.4.1.1 Checking the tyres

- ▶ Check the tyre wear. The tyre is worn if the anti-puncture protection or the carcass cords are visible.
- ⇒ A specialist dealer will need to change the tyre if it is worn.

### 7.4.1.2 Checking the rims

- ▶ Check the *rims* for wear. The rims are worn as soon as the black, all-round groove on the pad friction surface becomes invisible.
- ⇒ Contact your specialist dealer to have the rims replaced. We recommend that you also replace the *rims* at the same time as every second brake lining replacement.

### 7.4.1.3 Checking and adjusting the tyre pressure – Dunlop valve

Only applies to pedelecs with this equipment



The tyre pressure cannot be measured on the simple Dunlop valve. The tyre pressure is therefore measured in the filling hose when pumping slowly with the bicycle pump.

It is recommendable to use a bicycle pump with a pressure gauge. The operating instructions for the bicycle pump must be adhered to.

- 1 Unscrew and remove the valve cap.
- 2 Connect the bicycle pump.
- 3 Pump up the tyre slowly and pay attention to the tyre pressure in the process.
- 4 Correct the tyre pressure according to specifications in the Pedelec pass.
- 5 If the tyre pressure is too high, unfasten the union nut, let air out and re-tighten the union nut.
- 6 Remove the bicycle pump.
- 7 Screw the valve cap tight.
- 8 Screw the rim nut gently against the rim with the tips of your fingers.

#### 7.4.1.4 Checking and adjusting the tyre pressure – Presta valve

Only applies to pedelecs with this equipment



✓ It is recommendable to use a bicycle pump with a pressure gauge. The operating instructions for the bicycle pump must be adhered to.

- 1 Unscrew and remove the valve cap.
- 2 Open the knurled nut around four turns.
- 3 Carefully apply the bicycle pump so that the valve insert is not bent.
- 4 Pump up the tyre slowly and pay attention to the tyre pressure in the process.
- 5 Correct the tyre pressure as per the specifications on the tyre.
- 6 Remove the bicycle pump.
- 7 Tighten the knurled nut with your fingers.
- 8 Screw the valve cap tight.
- 9 Screw the rim nut gently against the rim with the tips of your fingers.

#### 7.4.1.5 Checking and adjusting the tyre pressure – Schrader valve

Only applies to pedelecs with this equipment



✓ It is recommendable to use a bicycle pump with a pressure gauge. The operating instructions for the bicycle pump must be adhered to.

- 1 Unscrew and remove the valve cap.
  - 2 Attach the bicycle pump.
  - 3 Pump up the tyre slowly and pay attention to the tyre pressure in the process.
- ⇒ The tyre pressure has been adjusted as per the specifications.
- 4 Remove the bicycle pump.
  - 5 Screw the valve cap tight.
  - 6 Screw the rim nut (1) gently against the rim with the tips of your fingers.

#### 7.4.2 Brake system



##### Crash caused by brake failure

Worn brake discs and brake linings, as well as a lack of hydraulic fluid in the brake cable, reduce the braking power. This may cause a crash with injuries.

- ▶ Check the brake disc, brake linings and hydraulic brake system on a regular basis. Contact your specialist dealer if any of these components have become worn.

The maintenance interval for the brake depends on the weather conditions and how frequent the bicycle is used. If the pedelec is used under extreme conditions such as rain, dirt or high mileage, maintenance must be performed more frequently.

#### 7.4.3 Checking the brake linings for wear

Check brake linings after brake has been fully applied 1,000 times.

- 1 Check that the brake linings are no less than 1.8 mm wide at any point and no less than 2.5 mm between the brake lining and supporting plate.
  - 2 Push brake lever and hold. In doing so, check the transport safety wear gauge can fit between the brake lining supporting plates.
- ⇒ The brake linings have not reached their wear limit. Contact your specialist dealer if any of these components have become worn.

#### 7.4.4 Checking the pressure point

- ▶ Pull brake lever and hold repeatedly several times.
- ⇒ If you are unable to clearly detect the pressure point and it changes, the brake needs to be vented. Contact your specialist dealer.

#### 7.4.5 Checking the brake discs for wear

- ▶ Check that the brake disc measures no less than 1.8 mm in depth at any point.
- ⇒ The brake discs have not reached their wear limit yet; brake discs need to be replaced if they have. Contact your specialist dealer.

### 7.4.6 Checking the electrical cables and brake cables

- ▶ Check all visible electrical cables and Bowden cables for damage. If the sheathing is compressed, a brake is defective or a light does not work, the pedelec must be removed from service until the lines or cables have been repaired. Contact your specialist dealer.

### 7.4.7 Checking the gear shift

- ▶ Check the gear shift and the *shifter* or the *gear twist grip* setting and adjust as necessary.

### 7.4.8 Checking the stem

- ▶ The stem and quick release system must be inspected at regular intervals. The specialist dealer should adjust them if necessary.
- ▶ If the hexagon socket head screw is also loosened, the headset backlash also needs to be adjusted. Medium-strength thread locker, such as Loctite blue, then needs to be applied to the loosened screws and the screws tightened as per specifications.
- ▶ Contact your specialist dealer if there is any wear or signs of corrosion.

### 7.4.9 Checking the USB port

#### Notice

Any moisture penetrating through the USB port may cause a short circuit in the *display*.

- ▶ Regularly check the position of the *cover on the USB port* and adjust it as necessary.

### 7.4.10 Checking the belt and chain tension

#### Notice

Excessive chain tension increases wear.

If the chain tension is too low, there is a risk that the *chain* or the *drive belt* will slip off the *chain wheels*.

- ▶ Check the chain tension once a month.

- 1 Check the chain tension in three or four positions, turning the crank a full revolution.

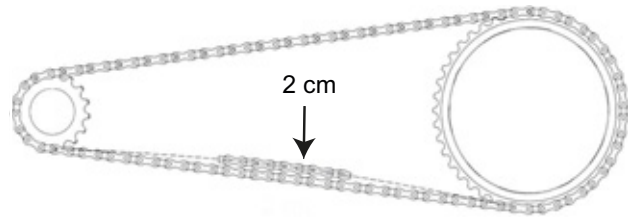

Figure 34: Checking the chain tension

- 2 If the *chain* can be pushed more than 2 cm, the *chain* or *drive belt* will need to be tensioned again by the specialist dealer.
  - 3 If the *chain* or the *drive belt* can only be pushed up and down less than 1 cm, you will need to slacken the *chain* or the *drive belt*.
- ⇒ The optimum chain tension is achieved if the *chain* or the *drive belt* can be pushed a maximum of 2 cm in the middle between the pinion and the toothed wheel. The crank must also turn without resistance.
- 4 If a hub gear is fitted, the rear wheel must be pushed backwards or forwards to tighten the chain. Contact your specialist dealer.
  - 5 Check the handlebar grip is firmly in position.





## 8 Maintenance

### WARNING

#### Injury due to damaged brakes

Special tools and specialist knowledge are required to repair the brakes. Incorrect or unauthorised assembly can damage the brakes. This may lead to an accident with injuries.

- ▶ Only specialist dealers may carry out repairs on brakes.
- ▶ Only carry out work or changes, such as dismantling, sanding or painting, which are permitted and described in the brake operating instructions.

#### Injury to the eyes

Problems may arise if the settings are not made properly and you may sustain serious injuries as a result.

- ▶ Always wear safety glasses during maintenance work.

### CAUTION

#### Crash and falling caused by unintentional activation

There is a risk of injury if the drive system is activated unintentionally.

- ▶ Remove the battery before inspection.

#### Crash caused by material fatigue

If the service life of a component has expired, the component may suddenly fail. This may cause a crash with injuries.

- ▶ Have the specialist dealer carry out basic cleaning of the pedelec every six months, preferably at the same time as the required servicing work.

### CAUTION

#### Hazard for the environment due to toxic substances

The brake system contains toxic and environmentally harmful oils and lubricants. Such fluids will contaminate if they enter the sewers or groundwater.

- ▶ Dispose of lubricants and oils left over after repairs in an environmentally responsible way in accordance with statutory regulations.

### Notice

The motor is maintenance-free and may only be opened by qualified specialist personnel.

- ▶ Never open the motor.

You must have the specialist dealer perform maintenance every six months as a minimum. This is the only way to ensure that the pedelec remains safe and fully functional. No matter whether disc brakes need replacing, brakes venting or wheels changing, many maintenance tasks require technical expertise, special tools and special lubricants. The pedelec may become damaged if the stipulated maintenance intervals and procedures are not carried out. That is why only specialist dealers may carry out maintenance.

- ▶ The retailer will check the pedelec based on the maintenance instructions in Section 11.3.
- ▶ The specialist dealer will inspect the pedelec for any signs of material fatigue during basic cleaning.
- ▶ The specialist dealer will check the software version of the drive system and update it. The electrical connections are checked, cleaned and preservative agent is applied. The electrical cables are inspected for damage.



- ▶ The specialist dealer will dismantle and clean the entire suspension fork interior and exterior. They will clean and lubricate the dust seals and slide bushings, check the torques and adjust the fork to the rider's preferred position. They will also replace the sliding collar if the clearance is too great (more than 1mm on the fork bridge).
- ▶ The specialist dealer will fully inspect the interior and exterior of the rear frame damper, overhaul the rear frame damper, replace all air seals on air forks, overhaul the air suspension, change the oil and replace the dust wipers.
- ▶ They will pay particular attention to rim and brake wear. The spokes are re-tightened in accordance with the findings.

## 8.1 Suspension system

The correct execution of maintenance on the suspension system not only guarantees a long service life, but also ensures optimal performance. Each maintenance interval shows the maximum cycling hours for the corresponding type of recommended maintenance. Depending on terrain and environmental conditions, the performance can be optimised through shorter maintenance intervals.

### 8.1.1 Rear frame damper

Only applies to pedelecs with this equipment

#### Maintenance intervals

RockShox rear frame damper		
<input type="checkbox"/>	Service air chamber assembly	Every 50 hours
<input type="checkbox"/>	Service damper and spring	Every 200 hours
FOX rear frame damper		
<input type="checkbox"/>	Complete maintenance (full interior and exterior inspection, damper overhaul, air spring overhaul, oil change and dust wiper replacement)	Every 125 hours or once a year
Suntour rear frame damper		
<input type="checkbox"/>	Complete shock absorber service including damper reassembly and air seal replacement	Every 100 hours

### WARNING

#### Injury due to explosion

The air chamber is pressurised. If the air system is serviced in a rear frame damper, it can explode and cause serious injury.

- ▶ Wear safety goggles, protective gloves and safety clothing when assembling or servicing the vehicle.
- ▶ Release the air for the air chambers. Detach all air insert fitments.
- ▶ Never service or dismantle a rear frame damper if it has not completely rebounded.

### WARNING

#### Intoxication from suspension oil

Suspension oil irritates the respiratory tract, leads to germ cell mutations and sterility, causes cancer and is toxic to touch.

- ▶ Always wear safety goggles and nitrile gloves when working with suspension oil.
- ▶ Never perform maintenance when you are pregnant.
- ▶ Use an oil catchment tray under the section where the rear frame damper is serviced.

### CAUTION

#### Hazard for the environment due to toxic substances

The rear frame damper contains toxic and environmentally harmful oils and lubricants. Such fluids will contaminate if they enter the sewers or groundwater.

- ▶ Dispose of lubricants and oils left over after repairs in an environmentally responsible way in accordance with statutory regulations.

Special tools, special lubricants and knowledge of suspension components are required to maintain and repair the rear frame damper.

The rear frame damper may become damaged if the procedure is not followed as described. Only specialist dealers may carry out maintenance on rear frame damper.

## 8.1.2 Suspension fork

Only applies to pedelecs with this equipment

### Maintenance intervals

Suntour suspension fork		
<input type="checkbox"/>	<b>Maintenance 1</b> Functional check, fastening and wear test	Every 50 hours
<input type="checkbox"/>	<b>Maintenance 2</b> Maintenance 1 + cleaning entire fork interior and exterior / cleaning and lubrication of dust seals and guides/ plastic bushings / check torques	Every 100 hours
FOX suspension fork		
<input type="checkbox"/>	Full maintenance (complete interior/ exterior inspection, damper overhaul, replacement of air seals on air forks, air suspension overhaul, oil change and dust wiper replacement).	Every 125 hours or once a year
RockShox suspension fork		
<input type="checkbox"/>	Stanchions for: Paragon™, XC™ 28, XC 30, 30™, Judy®, Recon™, Sektor™, 35™*, Bluto™, REBA®, SID®, RS-1™, Revelation™, PIKE®, Lyrik™, Yari™, BoXXer	Every 50 hours
<input type="checkbox"/>	Maintenance of spring and damper unit for: Paragon, XC 28, XC 30,30 (2015 and earlier), Recon (2015 and earlier), Sektor (2015 and earlier), Bluto (2016 and earlier), Revelation (2017 and earlier), REBA (2016 and earlier), SID (2016 and earlier), RS-1 (2017 and earlier), BoXXer (2018 and earlier)	Every 100 hours
<input type="checkbox"/>	Maintenance of spring and damper unit for: 30 (2016+), Judy (2018+), Recon (2016+), Sektor (2016+), 35 (2020+)*, Revelation (2018+), Bluto (2017+), REBA (2017+), SID (2017+), RS-1 (2018+), PIKE (2014+), Lyrik (2016+), Yari (2016+), BoXXer (2019+)	Every 200 hours

### WARNING

#### Injury due to explosion

The air chamber is pressurised. If the air system is serviced in a faulty suspension fork, it can explode and cause serious injury.

- ▶ Wear safety goggles, protective gloves and safety clothing when assembling or servicing the vehicle.
- ▶ Release the air for the air chambers. Detach all air insert fitments.
- ▶ Never service or dismantle a suspension fork if it has not completely rebounded.

### CAUTION

#### Hazard for the environment due to toxic substances

The suspension fork contains toxic and environmentally harmful oils and lubricants. Such fluids will contaminate if they enter the sewers or groundwater.

- ▶ Dispose of lubricants and oils left over after repairs in an environmentally responsible way in accordance with statutory regulations.

Special tools, special lubricants and knowledge of suspension components are required to service and repair suspension forks.

The suspension fork may be damaged if procedures are not followed as described. Only specialist dealers may carry out maintenance on the suspension fork.

### 8.1.3 Suspension seat post

Only applies to pedelecs with this equipment

#### Maintenance intervals

by.schulz seat post		
<input type="checkbox"/>	Check all screws for correct tightening torques for: G1 and G2	After 250 km and every 1,500 km
Suntour suspension seat post		
<input type="checkbox"/>	<b>Maintenance 1</b>	Every 100 hours
RockShox suspension seat post		
<input type="checkbox"/>	Venting of remote control lever and/or maintenance of lower seat post unit for: Reverb™ A1/A2/B1, Reverb Stealth A1/A2/B1/C1*, Reverb AXS™ A1*	Every 50 hours
<input type="checkbox"/>	Venting of remote control lever and/or maintenance of lower seat post unit for: Reverb B1, Reverb Stealth B1/C1*, Reverb AXS A1*	Every 200 hours
<input type="checkbox"/>	Complete maintenance of seat post for: Reverb A1/A2, Reverb Stealth A1/A2	Every 200 hours
<input type="checkbox"/>	Complete maintenance of seat post for: Reverb B1, Reverb Stealth B1	Every 400 hours
<input type="checkbox"/>	Complete maintenance of seat post for: Reverb AXS A1*, Reverb Stealth C1*	Every 600 hours
All other suspension seat posts		
<input type="checkbox"/>	Maintenance	Every 100 hours

Special tools, special lubricants and knowledge of suspension components are required to service and repair suspension seat posts.

The suspension seat post may be damaged if procedures are not followed as described. Only specialist dealers may carry out maintenance on the suspension seat post.

### 8.2 Axle with quick release



#### Crash caused by unfastened quick release

A faulty or incorrectly installed quick release may become caught in the brake disc and block the wheel. This will cause a crash.

- ▶ Install the front wheel quick release lever on the opposite side to the brake disc.

#### Crash caused by faulty or incorrectly installed quick release

The brake disc becomes very hot during operation. Parts of the quick release may become damaged as a result. The quick release comes loose. This will cause a crash with injuries.

- ▶ The front wheel quick release lever and the brake disc must be situated on opposite sides.

#### Crash caused by incorrectly set clamping force

Excessively high clamping force will damage the quick release and cause it to lose its function.

Insufficient clamping force will cause a detrimental transmission of force. The suspension fork or the frame may break. This will cause a crash with injuries.

- ▶ Never fasten a quick release using a tool (e.g. hammer or pliers).
- ▶ Only use the clamping lever with the specified set clamping force.

### 8.2.1 Checking the quick release

- ▶ Check the position and clamping force of the quick release lever. The quick release lever must be flush with the lower housing. You must be able to see a slight impression on the palm of your hand when you close the quick release lever.



Figure 35: Adjusting the quick release clamping force

- ▶ Use a 4 mm hexagon socket spanner to tighten the clamping lever clamping force if required. Check the quick release lever position and clamping force.

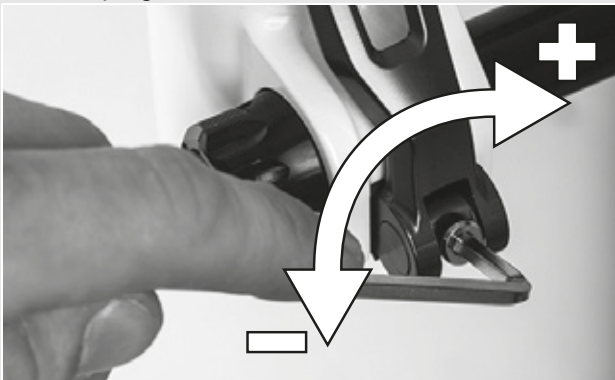

Figure 36: Adjusting the quick release clamping force

### 8.3 Maintaining the stem

Incorrectly fastened screws may come loose due to impact. The stem may no longer be firmly fixed in its position as a result. This will cause a crash with injuries.

- ▶ Check the handlebars and the stem's quick release system are firmly in position after the first two hours of riding.

### 8.4 Adjusting the gear shift

If you cannot select the gears effortlessly, you will need to adjust the setting for the shift cable tension.

- ▶ Carefully pull the *adjusting sleeve* away from the shifter housing, turning it as you do so.
- ▶ Check the gear shift function after each adjustment.

### 8.4.1 Cable-operated gear shift, single-cable

Only applies to pedelecs with this equipment

- ▶ For a smooth gear shift, adjust the adjusting sleeves on the shifter housing.

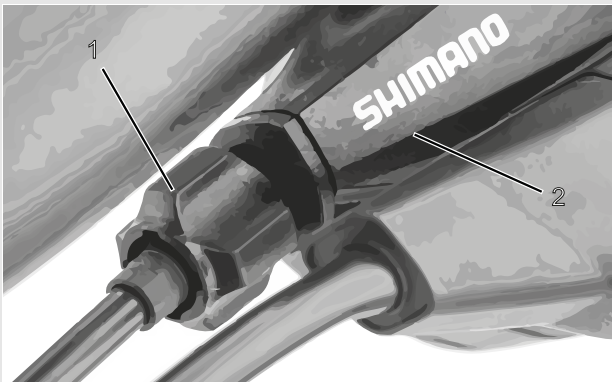

Figure 37: Adjusting sleeve (1) for the single-cable, cable-operated gear shift with shifter housing (2), example

### 8.4.2 Cable-operated gear shift, dual-cable

Only applies to pedelecs with this equipment

- ▶ For a smooth gear shift, set the adjusting sleeves underneath the chain stay on the frame.
- ▶ The shift cable has around 1 mm play when it is pulled out gently.

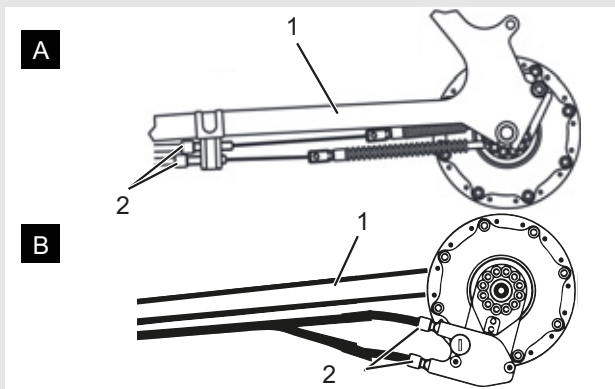

Figure 38: Adjusting sleeves (2) on two alternative versions (A and B) of a dual-cable, cable-operated gear shift on the chain stay (1)

### 8.4.3 Cable-operated twist grip, dual-cable

Only applies to pedelecs with this equipment

- ▶ For a smooth gear shift, set the adjusting sleeves on the shifter housing.
- ⇒ There is noticeable play of around 2–5 mm (1/2 gear) when twisting the twist grip.

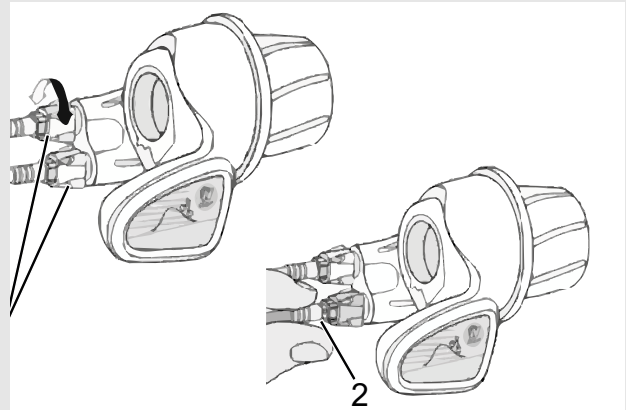

Figure 39: Twist grip with adjusting sleeves (1) and play of the gear shift (2)

## 9 Troubleshooting, fault clearance and repair

### 9.1 Troubleshooting and fault clearance

The components of the drive system are checked constantly and automatically. If an error is detected, an error message appears on the *display*. The drive may be shut off automatically, depending on the type of error.

#### 9.1.1 The drive system or display do not start up

If the display and/or the drive system do not start up, proceed as follows:

- 1 Check whether the battery is switched on. If not, start the battery.
- ⇒ Contact specialist dealer if the battery level indicator LEDs do not light up.
- 2 If the LEDs on the battery level indicator light up, but the drive system does not start up, remove the battery.
- 3 Insert the battery.
- 4 Start the drive system.
- 5 If the drive system does not start up, remove the battery.
- 6 Clean all the contacts with a soft cloth.
- 7 Insert the battery.
- 8 Start the drive system.
- 9 If the drive system does not start up, remove the battery.
- 10 Fully charge the battery.
- 11 Insert the battery.
- 12 Start the drive system.
- 13 Contact your specialist dealer if the drive system does not start up.

#### 9.1.2 Error message

If an error message is displayed, run through the following actions:

- 1 Make a note of the system message. There is a table containing all system messages in Section [6.3](#).
- 2 Shut off and re-start the drive system.
- 3 If the system message is still displayed, remove the battery and then re-insert.
- 4 Re-start the drive system.
- 5 If the system message is still displayed, contact your specialist dealer.

### 9.1.3 Assistance function errors

Symptom	Cause	Remedy
Assistance is not available.	Is the battery charged sufficiently?	<ol style="list-style-type: none"> <li>1 Check battery is charged.</li> <li>2 Recharge the battery if it is almost flat.</li> </ol>
	Are you riding up long inclines in summer weather or have you been carrying a heavy load for a long time? The battery may be too hot.	<ol style="list-style-type: none"> <li>1 Switch off the drive system.</li> <li>2 Wait a moment and then check again.</li> </ol>
	The rechargeable battery, the display or the assistance switch may be connected incorrectly or one or more of them may have a problem.	▶ Contact your specialist dealer.
	Is the speed too high?	▶ Check on-screen indicators. The electronic gear assistance only works up to a maximum speed of 25 km/h.
Assistance is not available.	Are the pedals being pushed?	▶ The pedelec is not a motorbike. Push the pedals.
	Is the assistance mode set to [OFF]?	<ol style="list-style-type: none"> <li>1 Set the assistance mode to a different level of assistance than [OFF].</li> <li>2 Contact your specialist dealer if you still feel that the no assistance is being supplied.</li> </ol>
	Is the system switched on?	▶ Press the battery on-off button to switch it on again.
The assisted journey distance is too short.	The journey distance can be shorter depending on the road conditions, the gear level and the entire light usage time.	<ol style="list-style-type: none"> <li>1 Check battery is charged.</li> <li>2 Recharge the battery if it is almost flat.</li> </ol>
	The battery does not perform as well in winter weather.	This does not indicate a problem.
	The battery is a consumable. Repeated charging and long periods of use cause the battery to degrade (loss of power).	▶ If the distance you can cover with one single charge is very short, replace the battery with a new one.
	Is the battery fully charged?	▶ If the distance covered with a fully charged battery has become shorter, the battery may be affected. Replace the battery with a new one.
It is difficult to pedal.	Are the tyres pumped to an adequate pressure?	▶ Pump up tyres.
	Is the assistance mode set to OFF?	<ol style="list-style-type: none"> <li>1 Set level of assistance to [BOOST].</li> <li>2 Contact your specialist dealer if you still feel that the no assistance is being supplied.</li> </ol>
	The battery charge might be low.	▶ Check how powerful assistance is again after charging the battery. Contact your specialist dealer if you still feel that the pedelec does not provide assistance.
	Have you switched on the system with your foot on the pedal?	<ol style="list-style-type: none"> <li>1 Switch the system on again without applying pressure to the pedal. Contact your specialist dealer if you still feel that the pedelec does not supply assistance.</li> </ol>

Table 27: Level of assistance error solution

### 9.1.4 Battery error

Symptom	Cause	Remedy
The battery discharges quickly.	The battery may be at the end of its useful life.	▶ Replace the battery with a new one.
The battery cannot be recharged.	Is the charger mains plug firmly connected to the socket?	<ol style="list-style-type: none"> <li>1 Pull out the charger mains plug and reconnect it again.</li> <li>2 Try charging again.</li> <li>3 If the battery still won't recharge, contact your specialist dealer.</li> </ol>
	Is the charger plug firmly inserted into the battery?	<ol style="list-style-type: none"> <li>1 Pull out the charger mains plug and reconnect it again.</li> <li>2 Try charging again.</li> <li>3 If the battery still won't recharge, contact your specialist dealer.</li> </ol>
	Is the adapter firmly connected to the charger plug or the battery's charging port?	<ol style="list-style-type: none"> <li>1 Connect the adapter firmly to the charger plug or the battery's charging port.</li> <li>2 Re-start the charging process.</li> <li>3 Contact your specialist dealer if the battery still does not charge.</li> </ol>
	Is the battery, the connection terminal for the battery charger, the charger adapter or the battery dirty?	<ol style="list-style-type: none"> <li>1 Wipe the connection terminal with a dry cloth to clean it.</li> <li>2 Try charging again.</li> <li>3 If the battery still won't recharge, contact your specialist dealer.</li> </ol>
The battery does not start charging when the charger is connected.	The battery may be at the end of its useful life.	▶ Replace the battery with a new one.
The battery and charger become hot.	The temperature of the battery or the charger may have exceeded the operating temperature range.	<ol style="list-style-type: none"> <li>1 Stop the charging process.</li> <li>2 Wait a while and then start charging again.</li> <li>3 If the battery is too hot to touch, there might be a problem with the battery. Contact your specialist dealer.</li> </ol>
The charger is hot.	If the charger is used continuously to charge batteries, it may become hot.	▶ Wait a while before using the charger again.
The LED on the charger does not light up.	Is the charger plug firmly inserted into the battery?	<ol style="list-style-type: none"> <li>1 Check the connection to the external body before inserting the charger plug again.</li> <li>2 If nothing changes, contact your specialist dealer.</li> </ol>
	Is the battery fully charged?	<p>The LED on the charger will go out when the battery is fully charged. This is not a malfunction.</p> <ol style="list-style-type: none"> <li>1 Pull out the charger mains plug and reconnect it again.</li> <li>2 Then try charging again.</li> <li>3 If the LED on the charger still does not light up, contact your specialist dealer.</li> </ol>
The battery cannot be removed.		▶ Contact your specialist dealer.
The battery cannot be inserted.		▶ Contact your specialist dealer.
Fluid is leaking from the battery.		▶ Observe all the safety instructions in Section 2 Safety.

Table 28: Error solution for battery



Symptom	Cause	Remedy
There is an unusual smell.		<ol style="list-style-type: none"> <li>1 Move away from the battery immediately.</li> <li>2 Contact the fire service immediately.</li> <li>3 Observe all the safety instructions in Section 2 Safety.</li> </ol>
Fumes are emitted from the battery.		<ol style="list-style-type: none"> <li>1 Move away from the battery immediately.</li> <li>2 Contact the fire service immediately.</li> <li>3 Observe all the safety instructions in Section 2 Safety.</li> </ol>

Table 28: Error solution for battery

### 9.1.5 Display errors

Symptom	Cause	Remedy
No data are shown on the monitor if you press the on-off button on the battery.	The battery charge level may be insufficient.	<ol style="list-style-type: none"> <li>1 Charge the battery.</li> <li>2 Switch the power on.</li> </ol>
	Is the power switched on?	▶ Keep the battery on-off button pressed down to switch on the power again.
	Is the battery charged?	▶ If the battery is fitted to the pedelec and is being charged, it cannot be switched on. Stop the charging process.
	Is the connector fitted to the power cable correctly?	▶ Check that the power cable connector has not been disconnected. If you are not sure, contact your specialist dealer.
	A component may be connected which the system is unable to recognise.	▶ Contact your specialist dealer.
The gear level is not shown on the display screen.	The gear level is only shown if the electronic gear shift is used.	▶ Check whether the power cable pug has been disconnected. If you are not sure, contact your specialist dealer.
The settings menu cannot be opened while you are riding.	The product is designed in such a way that the settings menu cannot be opened if the system detects that someone is riding the pedelec. This is not a malfunction.	▶ Stop the pedelec and then adjust the settings.
The time display is flashing "0:00".	The coin cell in the display has come to the end of its service life.	▶ Replace the coin cell in the display.

Table 29: Display error solution

### 9.1.6 Lighting does not work

Symptom	Cause	Remedy
The front light or rear light does not go on, even when the switch is pressed.	The basic settings in the electric drive system have probably been configured incorrectly. The light is defective.	<ol style="list-style-type: none"> <li>1 Take the pedelec out of service immediately.</li> <li>2 Contact your specialist dealer.</li> </ol>

Table 30: Error solution for battery

### 9.1.7 Other errors

Symptom	Cause	Remedy
Two beeps will sound if a switch is pressed but the switch cannot be operated.	Pressed switch mode has been deactivated.	▶ This is not a malfunction.

Table 31: Error solution for battery

Symptom	Cause	Remedy
Three beeps are sounded.	A fault or warning has occurred.	► This occurs when a warning or an error is shown on the display screen. Follow the instructions for the code indicated on screen in Section 6.2 System Messages.
When you use an electronic gear shift, you can feel that pedal assistance becomes weaker when the gear is changed.	This is because the computer sets the pedal assistance to the optimum level.	► This is not a malfunction.
A noise can be heard after switching.		► Contact your specialist dealer.
It is normal to hear a noise coming from the rear wheel when cycling as normal.	The gear shift setting may not have been made properly.	► Contact your specialist dealer.
If you stop the pedelec, gear transmission does not switch to the position pre-configured in the functional feature.	You may have applied too much pressure onto the pedals.	► It is easier to change gears if you press onto the pedals gently.

**Table 31: Error solution for battery**

## 9.2 Repair

Special knowledge and tools are required for many repairs. That is why only a specialist dealer may perform repairs such as:

- Replacing tyres and rims
- Replacing rims and brake linings or brake discs
- Replacing and tensioning the chain.

### 9.2.1 Original parts and lubricants

The individual pedelec parts have been carefully selected and matched to one other.

Only original parts and lubricants must be used for maintenance and repair.

The constantly updated accessory approval and parts lists are in Section 11 Documents and Drawings.

Observe the operating instructions for the new components.

### 9.2.2 Replacing the lighting

- Only use components of the respective power class for replacement.

### 9.2.3 Adjusting the headlight

- The *headlight* must be set, so that its light beam shines on the road 10 m in front of the pedelec.

### 9.2.4 Tyre clearance check

The tyre needs to be checked each time a suspension fork tyre is changed to another size.

- 1 Release pressure from the fork.
- 2 Press fork together fully.
- 3 Measure the gap between the top of the tyre and the crown's lower surface. The gap must not be less than 10 mm. If the tyre is too large, the tyre will touch the crown's lower surface if the fork is fully pressed together.
- 4 Release pressure on fork and pump it up again if it is an air suspension fork.
- 5 Take into account the fact that the gap will be smaller if there is a guard. Check again to ensure that there is sufficient clearance for the tyre.

## 10 Recycling and disposal



This device is marked according to the European Directive 2012/19/EU on waste electrical and electronic equipment – WEEE and the European



Directive 2006/66/EC on accumulators. The directive provides the framework for the return and recycling of used devices

across the EU. As a consumer, you are legally required to return all used batteries of any type. It is forbidden to dispose of batteries in domestic waste. The manufacturer is obliged to take back used and old batteries free of charge as per Section 9 German Batteries Act. You thus meet statutory obligations and help to protect the environment. The pedelec, battery, motor, display screen and charger are recyclable materials. You must dispose of and recycle them separately from the domestic waste in compliance with applicable statutory regulations. Separate collection and recycling saves reserves of raw materials and ensures that all the regulations for protection of health and the environment are adhered to when recycling the product and/or the battery.

- ▶ Never dismantle the pedelec, batteries or charger for disposal.
- ▶ The pedelec, display screen, the unopened and undamaged battery and the charger can be returned to any specialist dealer free of charge. Depending on the region, further disposal options may be available.
- ▶ Store the individual parts of the decommissioned pedelec in a dry place, free from frost, where they are protected from direct sunlight.

# 11 Documents

## 11.1 Parts list

### 11.1.1 Twenty 4 E 24"

21-26-3001

Model name	Twenty 4 E 24
Fork	SR Suntour XCT JR L
Damper	t.b.a.
Headset	semi-integrated Ahead
Handlebars	STYX
Handles	STYX
Stem	Die Cast with MonkeyLink Slot
Saddle	STYX
Seat post	STYX
Crank set	Samox
Pedals	STYX
Rear derailleur	Shimano Alivio RD-T4000-SGS Shadow Plus
Shifter	Shimano Altus SL-M315 Rapidfire Plus
Cassette/cassette sprocket	Shimano Altus CS-HG31-8 11-34T
Back-pedal brake	No
Brake system	Hydraulic disc brake
Front brake	Tektro HD-J285 hydraulic disc brake
Brake lever	Tektro HD-J285 2-Finger
Disc, front	160 Center Lock
Disc, rear	160 Center Lock
Front rim	STYX DDM-2
Rear rim	t.b.a.
Hub, front	Formula DC-19FQR
Hub, rear	Formula DC-25QR
Tyres	SCHWALBE Black Jack K-Guard
Front lamp	Fuxon F-16 EB
Rear lamp	Fuxon ML-009
Pannier rack	none
Guards	No
Chain guard	t.b.a.
Kickstand	t.b.a.
Motor	BOSCH Active Line Plus, BDU350
Rechargeable battery	BOSCH PowerPack 400/500, BBS265/BBS275
Display	Bosch Purion (BUI215)
Charger	t.b.a.

## 11.2 Assembly report

Date:

Frame number:

Components	Description		Criteria		Measures if rejected
	Assembly/inspection	Tests	Acceptance	Rejection	
Front wheel	Assembly		O.K.	Loose	Adjust quick release
Kickstand	Check mount fastening	Functional check	O.K.	Loose	Retighten screws
Tyres		Tyre pressure check	O.K.	Tyre pressure too low/ too high	Adjust tyre pressure
Frame	Check for damage – fracture, scratches		O.K.	Damage detected	<i>Take out of operation, new frame</i>
Handles, coverings	Check mount fastening		O.K.	Not provided	Retighten screws, new handles or coverings as specified in parts list
Handlebars, stem	Check mount fastening		O.K.	Loose	Retighten screws; new stem as specified in parts list if necessary
Steering headset	Check for damage	Functional check	O.K.	Loose	Retighten screws
Saddle	Check mount fastening		O.K.	Loose	Retighten screws
Seat post	Check mount fastening		O.K.	Loose	Retighten screws
Protective plate	Check mount fastening		O.K.	Loose	Retighten screws
Pannier rack	Check mount fastening		O.K.	Loose	Retighten screws
Attachments	Check mount fastening		O.K.	Loose	Retighten screws
Bell		Functional check	O.K.	No ring, too quiet, missing	New bell as specified in the parts list
<b>Suspension elements</b>					
Fork, suspension fork	Check for damage		O.K.	Damage detected	New fork as specified in the parts list
Rear frame damper	Check for damage		O.K.	Damage detected	New fork as specified in the parts list
Suspension seat post	Check for damage		O.K.	Damage detected	New fork as specified in the parts list
<b>Brake system</b>					
Brake lever	Check mount fastening		O.K.	Loose	Retighten screws
Brake fluid	Check fluid level		O.K.	Too little	Refill with brake fluid; new brake hoses if damaged
Brake linings	Check brake linings, brake discs or rims for damage		O.K.	Damage detected	New brake linings, brake discs or rims
Back-pedal brake braking armature	Check mount fastening		O.K.	Loose	Retighten screws
<b>Light system</b>					
Rechargeable battery	First examination		O.K.	Error message	<i>Take out of service</i> ; contact battery manufacturer, new battery
Light cabling	Connections, correct wiring		O.K.	Cable defective, no light	New cabling
Rear light	Side light	Functional check	O.K.	No constant light	<i>Take out of service</i> ; new rear light as specified in parts list; replace if necessary
Front light	Side light, daytime riding light	Functional check	O.K.	No constant light	<i>Take out of service</i> ; new front light as specified in parts list; replace if necessary
Reflectors	All complete, state, fastening		O.K.	Damaged or not all complete	New reflectors

Components	Description			Criteria	Measures if rejected
<b>Drive/gear shift</b>					
<b>Chain/cassette/pinion/chainring</b>	Check for damage		O.K.	Damage	Refasten if necessary or replace as specified in parts list
<b>Chain guard/spoke guard</b>	Check for damage		O.K.	Damage	Replace as specified in parts list
<b>Bottom bracket axle/crank</b>	Check mount fastening		O.K.	Loose	Retighten screws
<b>Pedals</b>	Check mount fastening		O.K.	Loose	Retighten screws
<b>Shifter</b>	Check mount fastening	Functional check	O.K.	Loose	Retighten screws
<b>Shift cables</b>	Check for damage	Functional check	O.K.	Loose or defective	Adjust shift cables; new shift cables if necessary
<b>Front derailleur</b>	Check for damage	Functional check	O.K.	Gear shift difficult or not possible	Adjust
<b>Rear derailleur</b>	Check for damage	Functional check	O.K.	Gear shift difficult or not possible	Adjust
<b>Electric drive</b>					
<b>Display</b>	Check for damage	Functional check	O.K.	No screen, defective screen display	Restart, test battery, new software, or new display – <i>take out of service</i>
<b>Electric drive control panel</b>	DriveCheck for damage	Functional check	O.K.	No response	Restart; contact control panel manufacturer, new control panel
<b>Tachometer</b>		Speed measurement	O.K.	Pedelec travelling 10% too fast/slow	Take pedelec out of service until the source of the error is found
<b>Cabling</b>	Visual inspection		O.K.	Failure in system, damage, kinked cables	New cabling
<b>Battery mount</b>	Firmly in position, lock, contacts	Functional check	O.K.	Loose; lock doesn't close, no contacts	New battery mount
<b>Motor</b>	Visual inspection and mount		O.K.	Damage, loose	Refasten motor, contact motor manufacturer, new motor
<b>Software</b>	Check version		In latest version	Not latest version	Import update

### Technical inspection, checking safety, test ride

Components	Description			Criteria	Measures if rejected
	Assembly/inspection	Tests	Acceptance	Rejection	
<b>Brake system</b>		Functional check	O.K.	No full braking; braking distance too long	Locate defective part in brake system and correct
<b>Gear shift under operating load</b>		Functional check	O.K.	Problems when shifting gear	Readjust gear shift
<b>Suspension components (fork, shock absorber, seat post)</b>		Functional check	O.K.	Suspension too deep or no longer exists	Locate defective component and correct
<b>Electric drive</b>		Functional check	O.K.	Loose connection, problems when riding, accelerate	Locate defective part in electric drive and correct
<b>Light system</b>		Functional check	O.K.	No continuous light, too bright	Locate defective part in light system and correct
<b>Test ride</b>			No strange noises	Strange noises	Locate source of noise and correct

Date:

Fitter's name:

Final inspection by workshop manager

## 11.3 Maintenance instructions

### Diagnosis and documentation of current status

Date:

Frame number:

Components	Frequency	Description			Criteria		Measures if rejected
		Inspection	Tests	Maintenance	Acceptance	Rejection	
Front wheel	6 months	Assembly			O.K.	Loose	Adjust quick release
Kickstand	6 months	Check mount fastening	Functional check		O.K.	Loose	Retighten screws
Tyres	6 months		Tyre pressure check		O.K.	Tyre pressure too low/too high	Adjust tyre pressure
Frame	6 months	Check for damage – fracture, scratches			O.K.	Damage detected	Take pedelec out of service, new frame
Handles, coverings	6 months	Wear; check if fastened securely			O.K.	Not provided	Retighten screws, new handles or coverings as specified in parts list
Handlebars, stem	6 months	Check mount fastening			O.K.	Loose	Retighten screws; new stem as specified in parts list if necessary
Steering headset	6 months	Check for damage	Functional check	Lubricating and adjustment	O.K.	Loose	Retighten screws
Saddle	6 months	Check mount fastening			O.K.	Loose	Retighten screws
Seat post	6 months	Check mount fastening			O.K.	Loose	Retighten screws
Protective plate	6 months	Check mount fastening			O.K.	Loose	Retighten screws
Pannier rack	6 months	Check mount fastening			O.K.	Loose	Retighten screws
Attachments	6 months	Check mount fastening			O.K.	Loose	Retighten screws
Bell	6 months		Functional check		O.K.	No ring, too quiet, missing	New bell as specified in the parts list
<b>Suspension elements</b>							
Fork, suspension fork	To manufacturer's specifications*	Check for damage – corrosion, fracture		Maintenance as specified by manufacturer Lubrication, oil change as specified by manufacturer	O.K.	Damage detected	New fork as specified in the parts list
Rear frame damper	To manufacturer's specifications*	Check for damage – corrosion, fracture		Maintenance as specified by manufacturer Lubrication, oil change as specified by manufacturer	O.K.	Damage detected	New fork as specified in the parts list
Suspension seat post	To manufacturer's specifications*	Check for damage		Maintenance as specified by manufacturer	O.K.	Damage detected	New fork as specified in the parts list
<b>Brake system</b>							
Brake lever	6 months	Check mount fastening			O.K.	Loose	Retighten screws
Brake fluid	6 months	Check fluid level		Depending on time of year	O.K.	Too little	Top up brake fluid; <i>take Pedelec out of service</i> if damaged; new brake hoses
Brake linings	6 months	Check brake linings, brake discs or rims for damage			O.K.	Damage detected	New brake linings, brake discs or rims
Back-pedal brake braking armature	6 months	Check mount fastening			O.K.	Loose	Retighten screws
Brake system	6 months	Check mount fastening		Functional check	O.K.	Loose	Retighten screws

\* see Section 8.1

Components	Frequency	Description			Criteria		Measures if rejected
		Inspection	Tests	Maintenance	Acceptance	Rejection	
<b>Light system</b>							
<b>Rechargeable battery</b>	6 months	First examination			O.K.	Error message	Contact battery manufacturer; <i>take out of service</i> , new battery
<b>Light cabling</b>	6 months	Connections, correct wiring			O.K.	Cable defective, no light	New cabling
<b>Rear light</b>	6 months	Side light	Functional check		O.K.	No constant light	New rear light as specified in parts list; replace if necessary
<b>Front light</b>	6 months	Side light, daytime riding light	Functional check		O.K.	No constant light	New front light as specified in parts list; replace if necessary
<b>Reflectors</b>	6 months	All complete, state, fastening			O.K.	Damaged or not all complete	New reflectors
<b>Drive/gear shift</b>							
<b>Chain/cassette/pinion/chainring</b>	6 months	Check for damage			O.K.	Damage	Refasten if necessary or replace as specified in parts list
<b>Chain guard/spoke guard</b>	6 months	Check for damage			O.K.	Damage	Replace as specified in parts list
<b>Bottom bracket axle/crank</b>	6 months	Check mount fastening			O.K.	Loose	Retighten screws
<b>Pedals</b>	6 months	Check mount fastening			O.K.	Loose	Retighten screws
<b>Shifter</b>	6 months	Check mount fastening	Functional check		O.K.	Loose	Retighten screws
<b>Shift cables</b>	6 months	Check for damage	Functional check		O.K.	Loose or defective	Adjust shift cables; new shift cables if necessary
<b>Front derailleur</b>	6 months	Check for damage	Functional check		O.K.	Gear shift difficult or not possible	Adjust
<b>Rear derailleur</b>	6 months	Check for damage	Functional check		O.K.	Gear shift difficult or not possible	Adjust
<b>Electric drive</b>							
<b>Display</b>	6 months	Check for damage	Functional check		O.K.	No screen, defective screen display	Restart, test battery, new software, or new display – <i>take out of service</i>
<b>Electric drive control panel</b>	6 months	DriveCheck for damage	Functional check		O.K.	No response	Restart; contact control panel manufacturer, new control panel
<b>Tachometer</b>	6 months		Speed measurement		O.K.	Pedelec travelling 10% too fast/slow	Take pedelec out of service until the source of the error is found
<b>Cabling</b>	6 months	Visual inspection			O.K.	Failure in system, damage, kinked cables	New cabling
<b>Battery mount</b>	6 months	Firmly in position, lock, contacts	Functional check		O.K.	Loose; lock doesn't close, no contacts	New battery mount
<b>Motor</b>	6 months	Visual inspection and mount			O.K.	Damage, loose	Refasten motor, contact motor manufacturer, new motor; <i>take out of service</i>
<b>Software</b>	6 months	Check version			In latest version	Not latest version	Import update



### Technical inspection, checking safety, test ride

Components	Description		Criteria		Measures if rejected
	Assembly/inspection	Tests	Acceptance	Rejection	
<b>Brake system</b>	6 months	Functional check	O.K.	No full braking; braking distance too long	Locate defective part in brake system and correct
<b>Gear shift under operating load</b>	6 months	Functional check	O.K.	Problems when shifting gear	Readjust gear shift
<b>Suspension components (fork, shock absorber, seat post)</b>	6 months	Functional check	O.K.	Suspension too deep or no longer exists	Locate defective component and correct
<b>Electric drive</b>	6 months	Functional check	O.K.	Loose connection, problems when riding, accelerate	Locate defective part in electric drive and correct
<b>Light system</b>	6 months	Functional check	O.K.	No continuous light, too bright	Locate defective part in light system and correct
<b>Test ride</b>	6 months	Functional check	No strange noises	Strange noises	Locate source of noise and correct

Date:	
Fitter's name:	
Final inspection by workshop manager	

#### Notes

**Notes**

## 11.4 Charger operating instructions



# Charger

BCS220 | BCS230 | BCS250

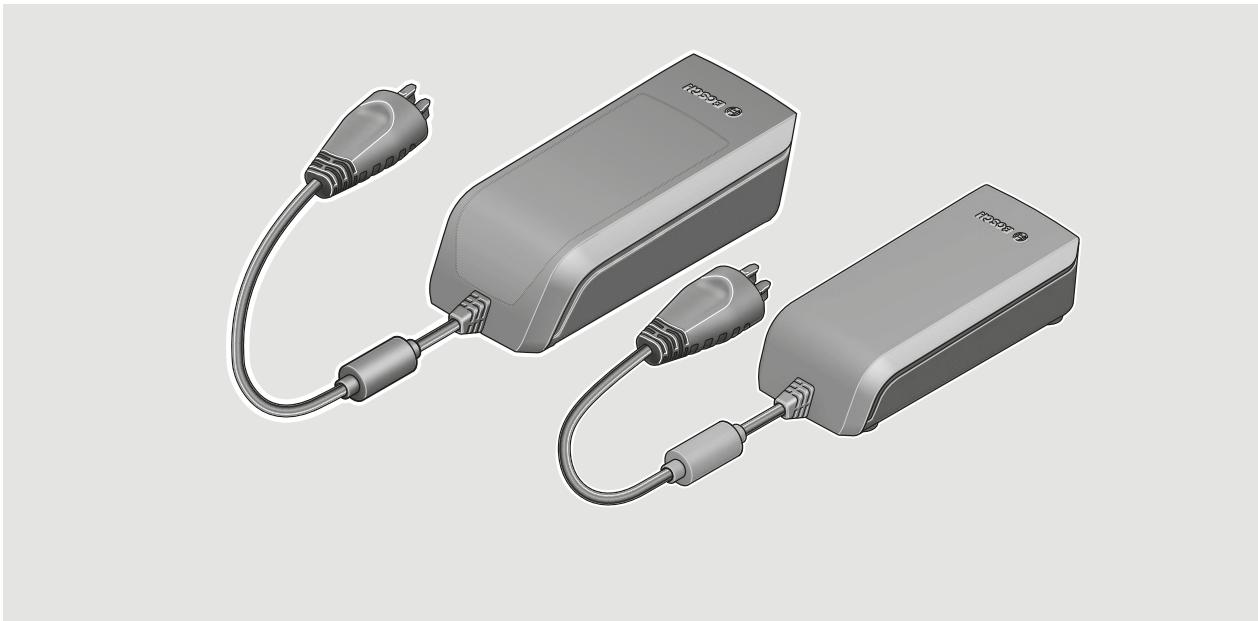

- de** Originalbetriebsanleitung
- en** Original operating instructions
- fr** Notice d'utilisation d'origine
- es** Instrucciones de servicio originales
- pt** Manual de instruções original
- it** Istruzioni d'uso originali
- nl** Oorspronkelijke gebruiksaanwijzing
- da** Original brugsanvisning
- sv** Originalbruksanvisning
- no** Original bruksanvisning
- fi** Alkuperäinen käyttöopas
- el** Πρωτότυπες οδηγίες λειτουργίας



2 |

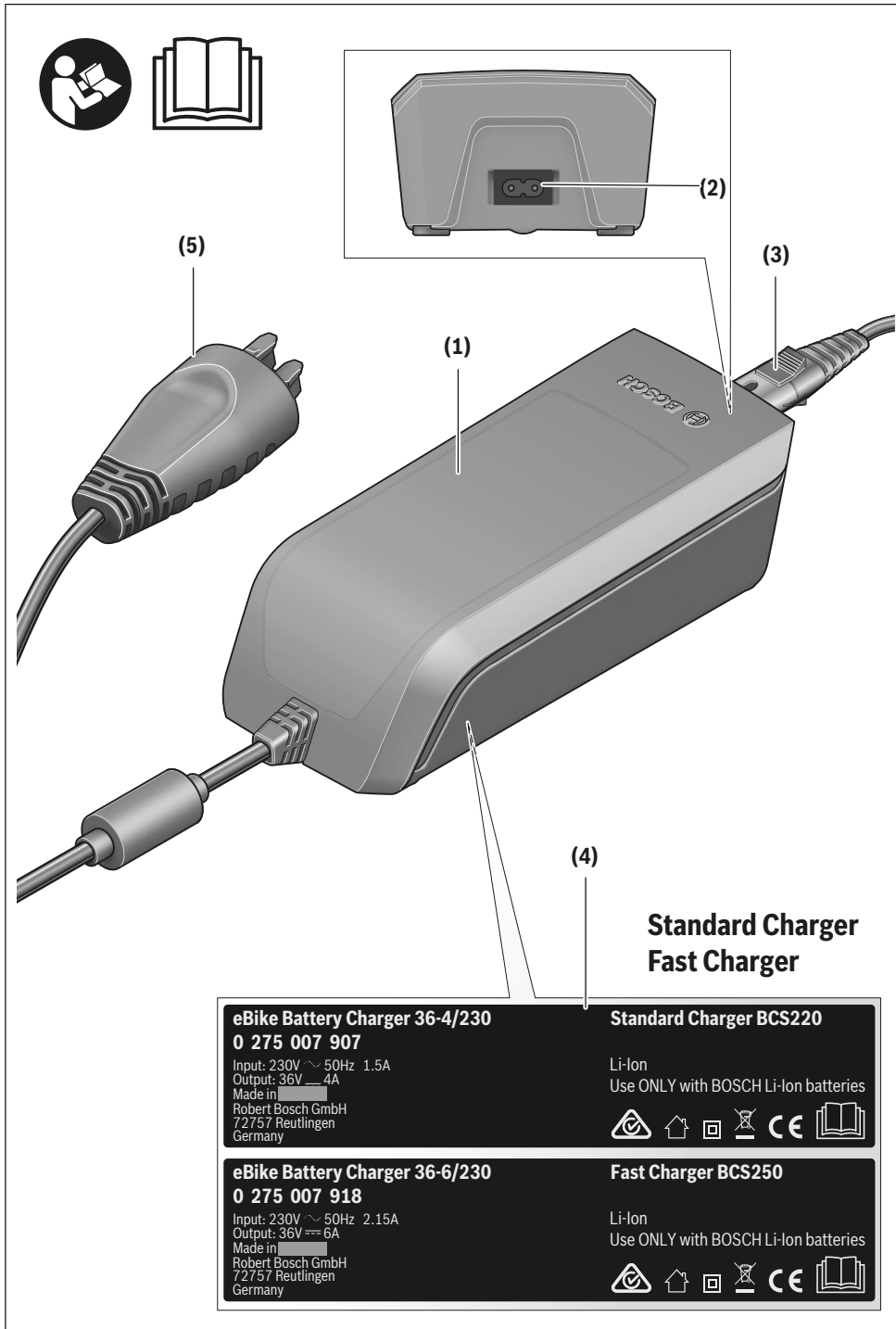

0 275 007 XCX | (13.03.2020)

Bosch eBike Systems

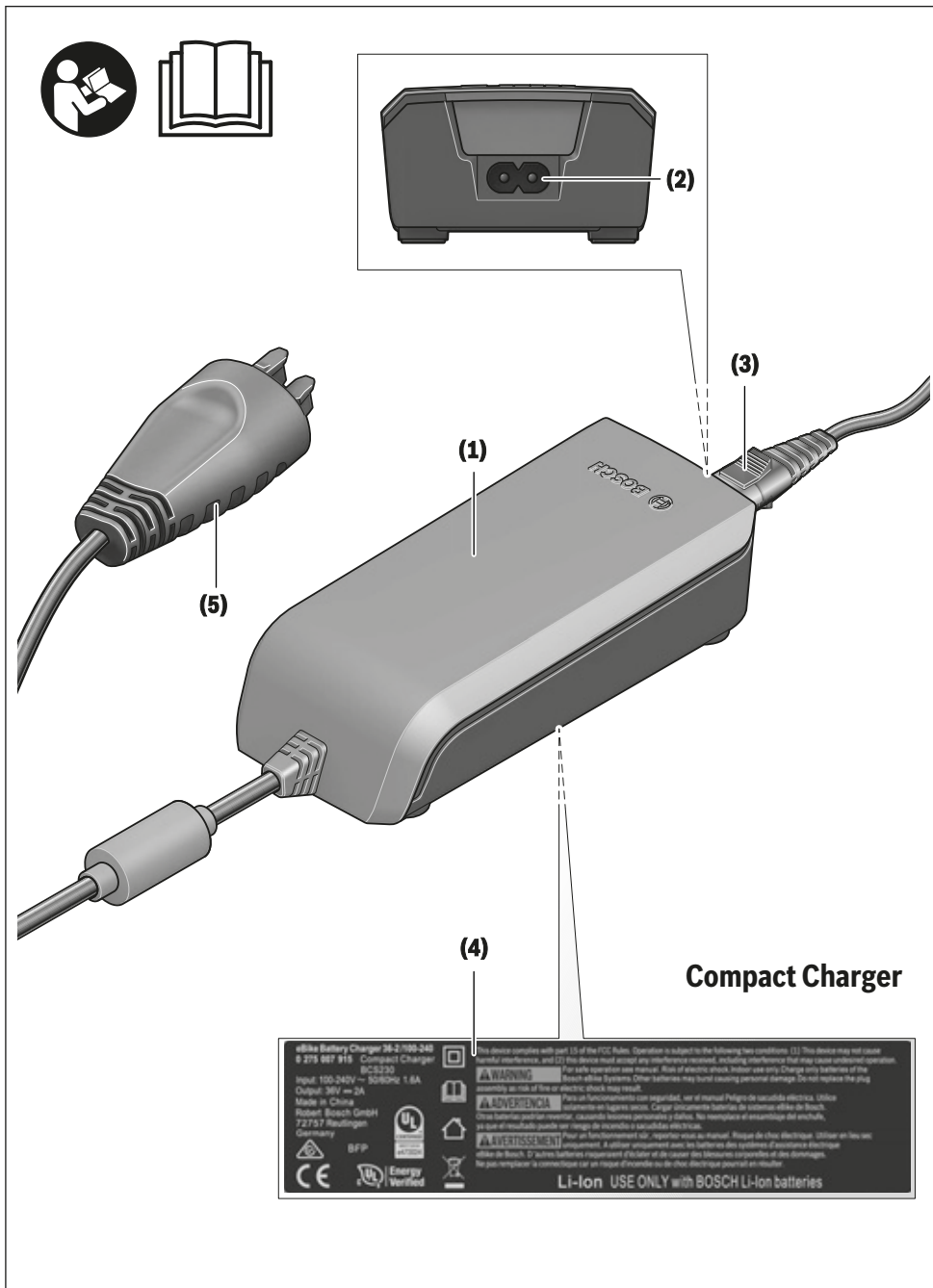

4 |

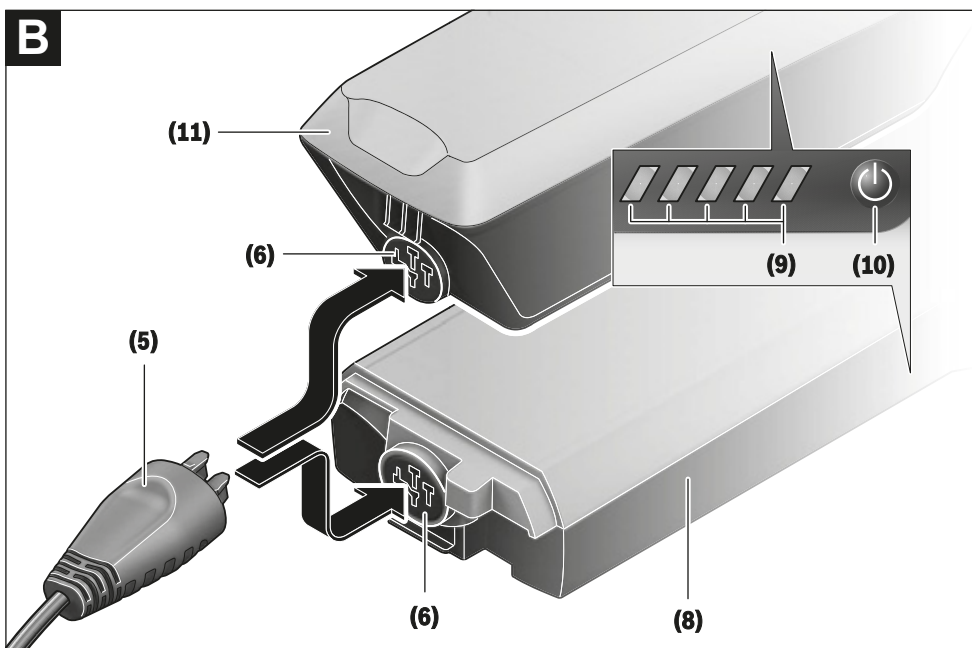
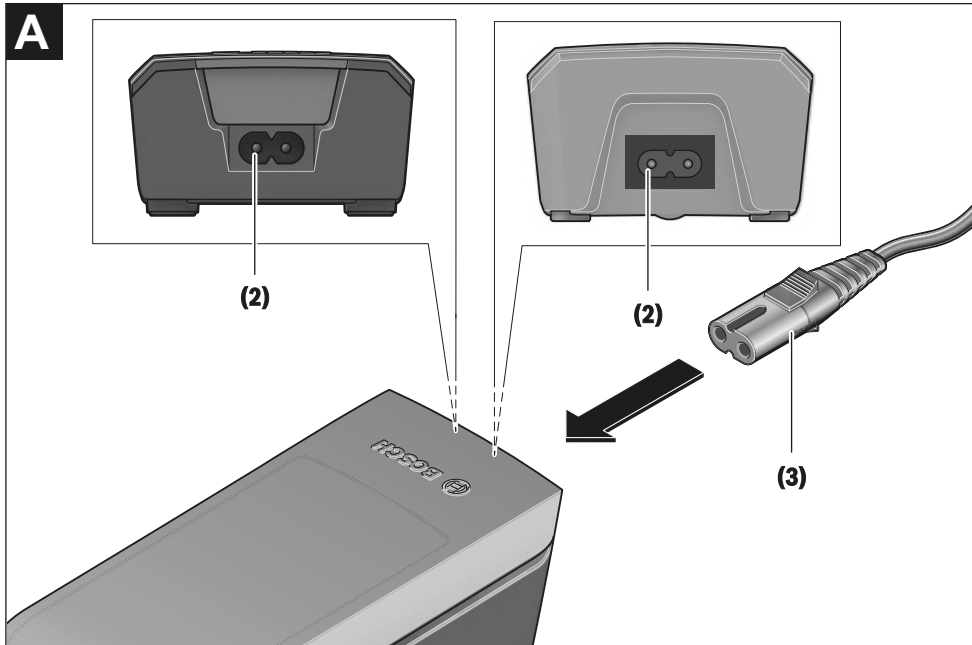

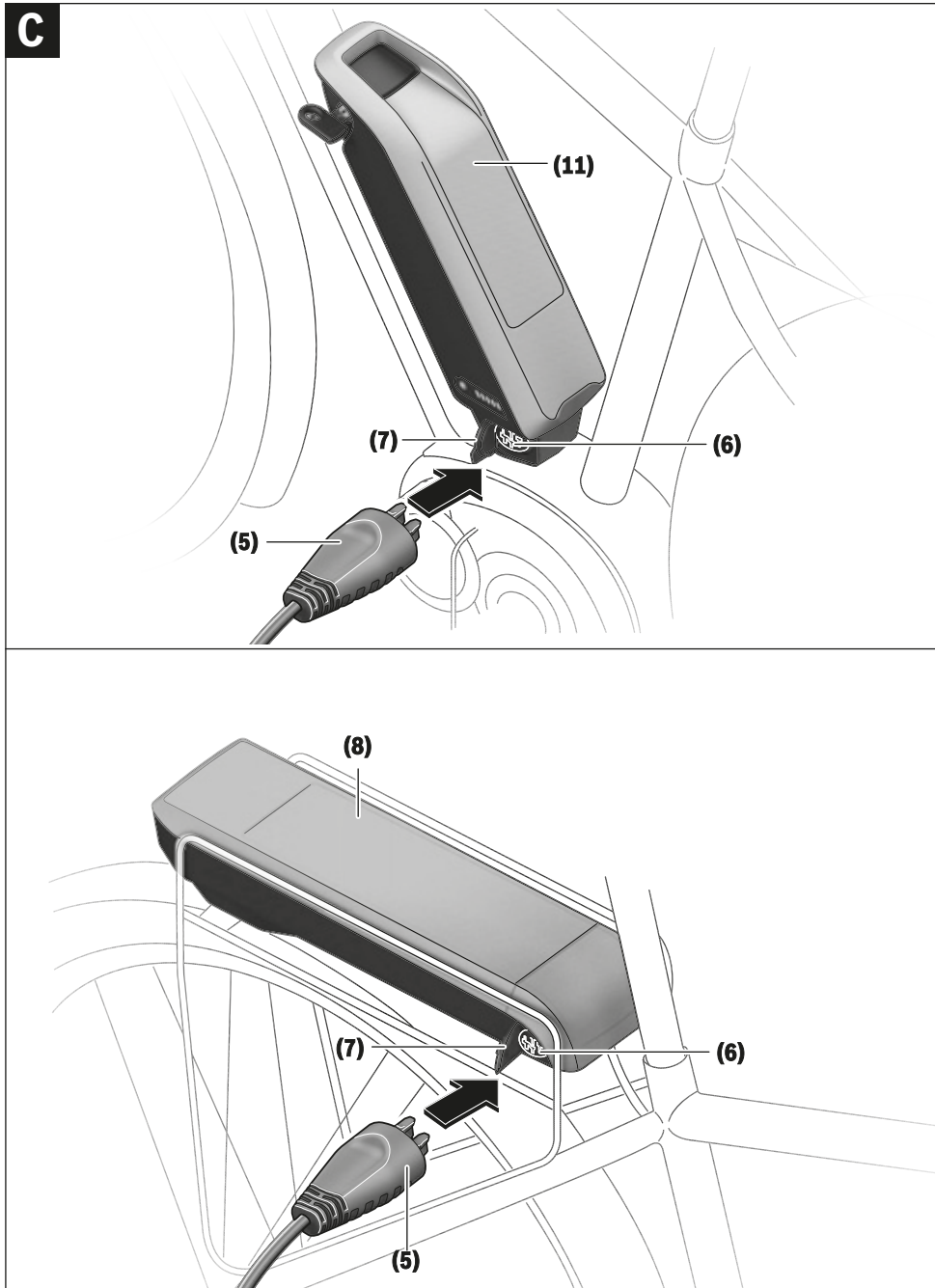

## Safety instructions



**Read all the safety and general instructions.** Failure to observe the safety and general instructions may result in electric shock,

fire and/or serious injury.

**Save all safety warnings and instructions for future reference.**

The term **battery** is used in these instructions to mean all original Bosch eBike rechargeable battery packs.



**Do not expose the charger to rain or wet conditions.** If water enters a charger, there is a risk of electric shock.

- ▶ **Charge only Bosch lithium-ion batteries that are approved for use in eBikes. The battery voltage must match the battery charging voltage of the charger.** Otherwise there is a danger of fire and explosion.
- ▶ **Keep the charger clean.** Dirt poses a risk of electric shock.
- ▶ **Always check the charger, cable and plug before use. Stop using the charger if you discover any damage. Do not open the charger.** Damaged chargers, cables and plugs increase the risk of electric shock.
- ▶ **Do not operate the charger on an easily ignited surface (e.g. paper, textiles, etc.) or in a flammable environment.** There is a risk of fire due to the charger heating up during operation.
- ▶ **Take care if you touch the charger while it is charging. Wear protective gloves.** The charger can get very hot, especially when the ambient temperature is high.
- ▶ **The battery may give off fumes if it becomes damaged or is used incorrectly. Ensure the area is well ventilated and seek medical attention should you experience any adverse effects.** The fumes may irritate the respiratory system.
- ▶ **The eBike battery must not be left unattended while charging.**
- ▶ **Supervise children during use, cleaning and maintenance.** This will ensure that children do not play with the charger.
- ▶ **Children or persons who, owing to their physical, sensory or mental limitations or to their lack of experience or knowledge, are not capable of safely operating the charger may only use this charger under supervision or after having been instructed by a responsible person.** Otherwise, there is a danger of operating errors and injuries.
- ▶ **Read and observe the safety warnings and directions contained in all the eBike system operating instructions and in the operating instructions of your eBike.**
- ▶ A sticker in English is adhered to the bottom of the charger (marked **(4)** in the diagram on the graphics page). This says: Use ONLY with BOSCH lithium-ion batteries.

## Product description and specifications

### Intended Use

In addition to the functions shown here, changes to software relating to troubleshooting and functional modifications may be introduced at any time.

The Bosch eBike chargers are intended exclusively for charging Bosch eBike batteries and must not be used for any other purpose.

### Product features

The numbering of the components shown refers to the illustrations on the graphics pages at the beginning of the manual.

Individual illustrations in these operating instructions may differ slightly from the actual conditions depending on the equipment of your eBike.

- (1) Charger
- (2) Device socket
- (3) Device connector
- (4) Charger safety instructions
- (5) Charging connector
- (6) Socket for charging connector
- (7) Charging socket cover
- (8) Rack-mounted battery
- (9) Operation/state of charge indicator
- (10) Battery on/off button
- (11) Standard battery



English – 2

## Technical data

Charger		Standard charger (36-4/230)	Compact charger (36-2/100-230)	Fast charger (36-6/230)
Product code		BCS220	BCS230	BCS250
Rated voltage	V~	207 to 264	90 to 264	207 to 264
Frequency	Hz	47 to 63	47 to 63	47 to 63
Battery charging voltage	V=	36	36	36
Charging current (max.)	A	4	2	6 <sup>A)</sup>
Charging time				
– PowerPack 300, approx.	hrs	2.5	5	2
– PowerPack 400, approx.	hrs	3.5	6.5	2.5
– PowerPack 500, approx.	hrs	4.5	7.5	3
Operating temperature	°C	0 to +40	0 to +40	0 to +40
Storage temperature	°C	+10 to +40	+10 to +40	+10 to +40
Weight, approx.	kg	0.8	0.6	1.0
Protection rating		IP 40	IP 40	IP 40

A) The charging current is limited to 4 A for the PowerPack 300 and for Classic+ Line batteries.

The specifications apply to a rated voltage [U] of 230 V. These specifications may vary at different voltages and in country-specific models.

## Operation

### Start-up

#### Connecting the charger to the mains (see figure A)

► **Pay attention to the mains voltage.** The voltage of the power source must match the voltage specified on the rating plate of the charger. Chargers marked 230 V can also be operated at 220 V.

Plug the device connector (3) of the power cable into the device socket (2) on the charger.

Connect the power cable (country-specific) to the mains.

#### Charging the removed battery (see figure B)

Switch the battery off and remove it from its holder on the eBike. When doing so, read and observe the operating instructions of the battery.

► **Ensure the battery is placed on clean surfaces only.** Avoid getting dirt, e.g. sand or soil, in the charging socket and contacts in particular.

Plug the charging connector (5) of the charger into the socket (6) on the battery.

#### Charging the battery on the bike (see figures C and D)

Switch the battery off. Clean the cover of the charging socket (7). Avoid getting dirt, e.g. sand or soil, in the charging socket and contacts in particular. Lift the cover of the charging socket (7) and plug the charging connector (5) into the charging socket (6).

► **There is a risk of fire due to the charger heating up during charging. Ensure the battery on the bike is completely dry and placed on a fireproof surface before charging.** If this is not possible, remove the battery from the holder and charge it in a more suitable location.

When doing so, read and observe the operating instructions of the battery.

#### Charging process for two batteries

If two batteries are fitted to an eBike, both batteries can be charged using the uncovered connection. To begin with, both batteries are charged one after the other until they reach approx. 80–90 % capacity, then they are both fully charged at the same time (the LEDs flash on both batteries).

When the bike is in operation, power is drawn from both batteries on an alternating basis.

If you take the batteries out of the holders, you can charge each one individually.

#### Charging process

The charging process begins as soon as the charger is connected to the battery or charging socket on the bike and to the mains.

**Note:** The charging process is only possible when the temperature of the eBike battery is within the permitted charging temperature range.

**Note:** The drive unit is deactivated during the charging process.

The battery can be charged with and without the on-board computer. When charging without the on-board computer, the charging procedure can be observed on the battery charge indicator.

When the on-board computer is connected, a charging notification appears on the display.

The state of charge is displayed by the battery charge indicator (9) on the battery and by the bars on the on-board computer.

The LEDs on the battery charge indicator (9) flash during the charging process. Each solid illuminated LED represents ap-

proximately 20 % of the charging capacity. The flashing LED indicates the next 20 % currently charging.

Once the eBike battery is fully charged, the LEDs go out immediately and the on-board computer is switched off. The charging process is terminated. The state of charge can be displayed for three seconds by pressing the on/off button (10) on the eBike battery.



Disconnect the charger from the mains and the battery from the charger.

When the battery is disconnected from the charger, the battery is automatically switched off.

**Note:** If you have charged the battery on the bike, carefully close the charging socket (6) with the cover (7) after charging, so that no dirt or water can get in.

If the charger is not disconnected from the battery after charging, after a few hours the charger will switch itself back on, check the state of charge of the battery and begin the charging procedure again if necessary.

## Errors – causes and corrective measures

Cause	Corrective measures
 <p>Battery defective</p>	<p><b>Two LEDs flash on the battery.</b></p> <p>Contact an authorised bike dealership.</p>
 <p>Battery too warm or too cold</p>	<p><b>Three LEDs flash on the battery.</b></p> <p>Disconnect the battery from the charger until the charging temperature range has been reached.</p> <p>Do not reconnect the battery to the charger until it has reached the correct charging temperature.</p>
 <p>The charger is not charging.</p>	<p><b>No LEDs flashing (one or more LEDs will remain permanently lit depending on the state of charge of the eBike battery).</b></p> <p>Contact an authorised bike dealership.</p>
<b>Charging not possible (no indicator on battery)</b>	
Connector not attached properly	Check all connections.
Battery contacts dirty	Carefully clean the battery contacts.
Plug socket, cable or charger defective	Check the mains voltage, have the charger checked over by a bike dealership.
Battery defective	Contact an authorised bike dealership.

## Maintenance and servicing

### Maintenance and cleaning

If the charger fails, please contact an authorised bike dealership.

### After-sales service and advice on using products

If you have any questions about the charger, contact an authorised bike dealership.

For contact details of authorised bike dealerships, please visit [www.bosch-ebike.com](http://www.bosch-ebike.com).

### Disposal

Chargers, accessories and packaging should be recycled in an environmentally friendly manner.

Do not dispose of chargers along with household waste.

**Only for EU countries:**



According to the European Directive 2012/19/EU on Waste Electrical and Electronic Equipment and its implementation into national law, chargers that are no longer usable must be collected separately and disposed of in an environmentally friendly manner.

**Subject to change without notice.**

## 12 Glossary

### Brake lever

*Source: EN 15194:2017:* lever used to apply the brake.

### Braking distance

*Source: EN 15194:2017:* distance travelled by a pedelec between the commencement of braking and the point at which the pedelec comes to rest.

### Cargo bike

*Source: DIN 79010:* bicycle mainly designed to carry goods.

### CE marking

*Source: Directive 2006/42/EC on Machinery:* the manufacturer uses the CE marking to declare that the Pedelec complies with the applicable requirements.

### City and trekking bicycles

*Source: EN-ISO 4210 - 2:* pedelec designed for use on public roads primarily for means of transportation or leisure.

### Consumables

*Source: EN 82079-1:* any part or material that is necessary for continued use or maintenance of the product.

### Decommissioning

*Source: DIN 31051:* intentional, unlimited interruption in an object's functional capability.

### Disc brake

*Source: EN 15194:2017:* brake in which brake pads are used to grip the lateral faces of a thin disc attached to or incorporated in the wheel hub.

### Drive belt

*Source: EN 15194:2017:* seamless ring belt which is used as a means of transmitting motive force.

### Electrical control system

*Source: EN 15194:2017:* electronic and/or electrical component, or an assembly of components provided for installation into a vehicle, together with all electrical connections and associated wiring for the motor electrical power assistance.

### Electrically power assisted cycle, pedelec

*Source: EN 15194:2017:* electrically power assisted cycle, equipped with pedals and an auxiliary electric motor, which cannot be propelled exclusively by means of the auxiliary electric motor, except in start-up assistance mode.

### Fault

*Source: EN 13306:2018-02, 6.1:* state of an item (4.2.1) characterized by inability to perform a required function (4.5.1), excluding the inability during preventive maintenance or other planned actions, or due to lack of external resources.

### Folding bicycle

*Source: EN-ISO 4210-2:* bicycle designed to fold into a compact form, facilitating transport and storage.

### Fork steerer

*Source: EN 15194:2017:* part of a fork that rotates about the steering axis of a bicycle frame head tube. It is normally connected to the fork crown or directly to the fork legs, and is normally the point of connection between the fork and the handlebar stem.

### Fracture

*Source: EN 15194:2017:* unintentional separation into two or more parts.

### Instruction handbook

*Source: ISO/FDIS 20607:2018:* part of the user information that machine manufacturers provide to machine operators; it contains guidance, instructions and tips related to the use of the machine in all its life cycle phases.

### Maintenance

*Source: DIN 31051:* maintenance is generally performed at regular intervals and often carried out by trained technical staff. This ensures a maximum service life and low wear and tear for the maintained items. Proper maintenance is often also a pre-requisite for providing a warranty.

### Maximum continuous power

*Source: ZEG:* the maximum continuous power is the maximum power for the electric motor output shaft during 30 minutes.

**Maximum saddle height**

*Source: EN 15194:2017:* vertical distance from the ground to the point where the top of the seat surface is intersected by the seat-post axis, measured with the saddle in a horizontal position and with the seat-post set to the minimum insertion-depth mark.

**Maximum tyre pressure**

*Source: EN 15194:2017:* maximum tyre pressure recommended by the tyre or rim manufacturer for a safe and efficient performance. If the rim and tyre both indicate a maximum tyre pressure, the maximum inflation pressure is the lower of the two pressures indicated.

**Minimum insertion depth mark**

*Source: EN 15194:2017:* mark indicating the minimum insertion-depth of handlebar stem into fork steerer (fork stem) or seat post into frame.

**Model year**

*Source: ZEG:* the model year refers to the first production year that the series-manufactured pedelec was manufactured in the version in question and is not always identical with the year of manufacture. The year of manufacture may be before the model year in some cases. If no technical modifications are introduced to the series, production may continue of pedelecs from a previous model year.

**Mountain bike**

*Source: EN-ISO 4210-2:* bicycle designed for use off-road on rough terrain, on public roads, and on public pathways, equipped with a suitably strengthened frame and other components, and, typically, with wide-section tyres with coarse tread patterns and a wide range of transmission gears.

**Off-road rough terrain**

*Source: EN 15194:2017:* coarse pebble tracks, forest trails, and other general off-road tracks where tree roots and rocks are likely to be encountered.

**Permitted total weight**

*Source: EN 15194:2017:* weight of the fully assembled pedelec plus the rider and baggage, as specified by the manufacturer.

**Quick-release device, quick release**

*Source: EN 15194:2017:* lever actuated mechanism that connects, retains or secures a wheel or any other component.

**Racing bicycle**

*Source: EN-ISO 4210-2:* bicycle intended for high-speed amateur use on public roads having a steering assembly with multiple grip positions allowing for an aerodynamic posture, a multi-speed transmission system, tyre width not greater than 28 mm and a maximum mass of 12 kg for the fully assembled bicycle.

**Seat post**

*Source: EN 15194:2017:* component that clamps the saddle (with a bolt or assembly) and connects it with the frame.

**Shut-off speed**

*Source: EN 15194:2017:* speed reached, by the pedelec, at the moment the current has dropped to zero or to the no load current value.

**Spare part**

*Source: EN 13306:2018-02, 3.5:* item intended to replace a corresponding item in order to retain or maintain the original required function of the item.

**Suspension fork**

*Source: EN 15194:2017:* front fork incorporating controlled, axial flexibility to reduce the transmission of road-shocks to the rider.

**Suspension frame**

*Source: EN 15194:2017:* frame incorporating controlled, vertical flexibility to reduce the transmission of road-shocks to the rider.

**Type number**

*Source: ZEG:* all pedelec models have an eight-digit type number which is used to specify the design model year, the type of pedelec and the version.

**Wear**

*Source: DIN 31051:* reduction in useful life (4.3.4), caused by chemical and/or physical processes.

**Weight of ready-to-ride bicycle**

*Source: ZEG:* the indicated weight for a ready-to-ride bicycle refers to the weight of a pedelec at the time of sale. The weight of each additional accessory must be added to this weight.

**Wheel**

*Source: EN 15194:2017:* assembly or combination of hub, spokes or disc, and rim, but excluding tyre assembly.

**Work environment**

*Source: EN ISO 9000:2015:* set of conditions under which work is performed.

**Year of manufacture**

*Source: ZEG:* the year of manufacture is the year in which the Pedelec was manufactured. The production period is always from August to July of the following year.

**Young adult bicycle**

*Source: EN-ISO 4210-2:* bicycle designed for use on public roads by a young adult whose weight is less than 40 kg, with maximum saddle height of 635 mm or more and less than 750 mm. (see ISO 4210).

**12.1 Abbreviations**

ABS anti-blocking system

ECP electronic cell protection

**12.2 Simplified terms**

The following terms are used for better legibility:

Term	Meaning
Operating instructions	Original operating instructions
Motor	Drive motor, sub-system

**Table 32: Simplified terms**

## 13 Appendix

### I. Translation of the original EC/EU Declaration of Conformity

#### Manufacturer

ZEG Zweirad-Einkaufs-Genossenschaft eG  
Longericher Strasse 2  
50739 Köln, Germany

#### Authorised representative for documentation\*

Janine Otto  
c/o ZEG Zweirad-Einkaufs-Genossenschaft eG  
Longericher Strasse 2  
50739 Köln, Germany

The machine, pedelec types:

21-26-3001 Twenty 4 E 24"

Bicycle for young adults

Year of manufacture 2020 and year of manufacture 2021, complies with the following applicable EU provisions:

- Machinery Directive 2006/42/EC
- Directive 2011/65/EU (RoHS)
- Electromagnetic Compatibility Directive 2014/30/EU.

The safety objectives in the Low Voltage Directive 2014/35/EU have been met in compliance with Appendix I, No. 1.5.1 of the Machinery Directive 2006/42/EC.

The following harmonised standards have been applied:

- ISO 20607:2018 Safety machinery – Instruction handbook – General drafting principles
- EN 15194:2017, Cycles – Electrically power assisted cycles – EPAC Bicycles

The following other technical standards have been applied:

- EN 11243:2016: Cycles – Pannier racks for bicycles – Requirements and test methods



Cologne, 29/07/2020

.....  
Egbert Hageböck, Chairman, ZEG Zweirad-Einkaufs-Genossenschaft eG

## II Declaration of conformity for incomplete machine

eBike Systems



### Assembly confirmation

#### Declaration of the manufacturer for the partly completed machinery

Manufacturer:

Robert Bosch GmbH  
Gerhard-Kindler-Straße 3  
72770 Reutlingen  
GERMANY

Robert Bosch GmbH  
Bosch eBike Systems  
Postfach 1342  
72703 Reutlingen  
www.bosch-ebike.de

List of valid Drive Unit numbers:

0275 007 020	0275 007 030	0275 007 040	0275 007 049
0275 007 022	0275 007 032	0275 007 041	0275 007 060
0275 007 023	0275 007 033	0275 007 042	0275 007 063
0275 007 024	0275 007 034	0275 007 043	0275 007 062
0275 007 025	0275 007 035	0275 007 045	0275 007 065
0275 007 027	0275 007 037	0275 007 046	0275 007 071
0275 007 028	0275 007 038	0275 007 047	0275 007 072
0275 007 029	0275 007 039	0275 007 048	0275 007 074
			0275 007 075

List of the applied and observed basic requirements of the "Declaration of Incorporation to appendix I, Machinery Directive 2006/42/EC" (OJ L 157, 09.06.2006, p.24):

No.	Essential Requirements
<b>1.1</b>	<b>GENERAL REMARKS</b>
1.1.2	Principles of safety integration
1.1.3	Materials and products
1.1.5	Design of machinery to facilitate its handling
1.1.6	Ergonomics
<b>1.2</b>	<b>CONTROL SYSTEMS</b>
1.2.1	Safety and reliability of control systems
1.2.3	Starting
1.2.4	Stopping
1.2.4.1	Normal stop
1.2.4.2	Operational stop
1.2.5	Selection of control or operating modes
1.2.6	Failure of the power supply
<b>1.3</b>	<b>PROTECTION AGAINST MECHANICAL HAZARDS</b>
1.3.2	Risk of break-up during operation
1.3.4	Risks due to surfaces, edges or angles
1.3.7	Risks related to moving parts
1.3.9	Risks of uncontrolled movements

No.	Essential Requirements
<b>1.5</b>	<b>RISKS DUE TO OTHER HAZARDS</b>
1.5.1	Electricity supply
1.5.2	Static electricity
1.5.4	Errors of fitting
1.5.5	Extreme temperatures
1.5.6	Fire
1.5.8	Noise
1.5.9	Vibrations
1.5.10	Radiation
1.5.11	External radiation
<b>1.6</b>	<b>MAINTENANCE</b>
1.6.2	Access to operating positions and servicing points
1.6.3	Isolations of energy sources
1.6.4	Operator intervention
<b>1.7</b>	<b>INFORMATION</b>
1.7.1	Information and warnings on the machinery
1.7.1.1	Information and information devices
1.7.2	Warning of residual risks
1.7.3	Marking of machinery
1.7.4	Instructions
1.7.4.1	General principles for the drafting of instructions
1.7.4.2	Contents of the instructions
1.7.4.3	Sales literature

The technical documents are generated as required in appendix VII B.

We undertake to transmit relevant information of the partly completed machinery in response to a reasoned request by the appropriate national authorities.

The technical documents may be reviewed at the following contact:

**Robert Bosch GmbH**  
**EB/ECA**  
**Gerhard-Kindler-Straße 3**  
**72770 Reutlingen**  
**GERMANY**

The product conforms to the following regulations:

Regulation (EC) No 1907/2006, (OJ L 396, 30.12.2006, p.1)	REACH
Regulation (EC) No 850/2004, (OJ L 158, 30.04.2004, p.7)	POP
Directive 2011/65/EU, (OJ L 174, 01.07.2011, p.88)	RoHS II
Directive 2014/30/EU, (OJ L 96, 29.03.2014, p.79)	EMC



eBike Systems



Page 3 of 3

The machinery is incomplete and must not be put into service until the machinery into which it is to be incorporated has been declared in conformity with the provisions of the directive.

Bosch eBike Systems  
Reutlingen, 26.03.2020

A handwritten signature in blue ink, appearing to read 'i.v. h.' followed by a stylized flourish.

Gunter Flinspach (EB/NE)  
Vice President

A handwritten signature in blue ink, appearing to read 'Thomas Raica' followed by a long, sweeping flourish.

Thomas Raica (EB/ECA)  
Director

## 14 Keyword index

- A**  
 Alternative equipment, 97  
 Articulated shaft,  
   - care 64
- B**  
 Basic cleaning 62  
 Battery housing, 18  
 Battery key, 18  
 Battery level indicator (battery), 18  
 Battery level indicator, 25  
 Battery lock, 18  
 Battery, 17  
   - charging, 50  
   - checking, 32  
   - cleaning, 63  
   - disposing of, 79  
   - inserting, 50  
   - removing, 50  
   - shipping 30  
   - transporting 30  
   Technical data 23, 24  
 Belt tension, 67  
 Brake calliper, 16  
 Brake disc, 16  
   - check 66  
 Brake lever, 25  
 Brake lining, 16  
   - check 66  
   - maintaining, 66  
 Brake,  
   - check brake cables 67  
   - check brake disc 66  
   - check brake linings 66  
   - check pressure point 26  
   - securing during transport 30  
 Break in operation, 31  
   - carrying out 31  
   - preparing 31  
 Button,  
   Minus, 53  
   On-Off (display), 53  
   Plus, 53  
   Push assist, 53
- C**  
 Cassette,  
   - care 64  
 Chain drive, 17  
 Chain guard,  
   - checking, 48  
 Chain tension, 67  
 Chain wheel, 17  
 Chain wheels,  
   - care 64  
 Chain, 14, 17  
   - care, 64  
   - maintaining, 67  
 Charger,  
   - disposing of, 79  
 Charging port cover, 18  
 Charging port, 18  
 Child seat, 46
- D**  
 Dimensions, 29
- Direction of travel, 17  
 Display,  
   - charging the battery, 53  
   - cleaning, 63  
 Drive system, 17  
   - switching off, 52  
   - switching on, 52
- E**  
 Electrical cable,  
   - check 67  
 Emergency stop system 12
- F**  
 Fork,  
   - care, 64  
   - setting the compression damper, 58  
   position 14  
 Frame battery,  
   - inserting, 50  
   - removing, 50  
 Frame,  
   - care, 64  
   - cleaning, 62  
   position 14  
 Front derailleur,  
   - care, 64  
 Front wheel brake, 16  
   - braking, 57  
 Front wheel, see Wheel
- G**  
 Gear shift twist grip, 25  
   - checking, 67  
 Gear shift,  
   - check 67  
   - maintaining, 67  
   - switching, 59, 60
- H**  
 Handlebars, 14, 25  
   - check 34  
   position 14  
 Headlight, 17  
 Hub, 15
- I**  
 Initial commissioning, 33
- J**  
 Jockey wheel,  
   - care 64  
 Journey information, 25  
   - switching, 54
- L**  
 Level of assistance,  
   - selecting, 54
- M**  
 Minimum insertion depth marking, 43  
 Minus button, 53  
 Model year, 8  
 Motor, 17  
   - cleaning, 63  
   Technical data 23  
 Mudguards,  
   - checking, 48
- O**  
 On-Off button (battery), 18  
 On-Off button,  
   Display, 53  
 On-screen indicator, 25, 47  
 Operating status indicator, 25
- P**  
 Pannier rack,  
   - changing, 49  
   - checking, 48  
   - using, 49  
 Pedal, 17  
   - care, 64  
   - cleaning, 61  
 Pedelec,  
   - shipping 30  
   - transporting 30  
 Plus button, 53  
 Push assist button, 53  
 Push assist,  
   - using, 54
- R**  
 Range, 25  
 Rear frame damper,  
   - cleaning, 61, 62  
 Rear light, 17  
 Rear wheel brake, 16  
 Riding light, 19  
   - checking function, 48  
 Rim, 15  
   - checking, 65
- S**  
 Saddle, 49  
   - changing the saddle tilt, 42  
   - changing the seat length, 43  
   - determining the saddle height, 42, 43  
   - using, 49  
   position 14  
 Seat post,  
   position 14  
 Shifter,  
   - checking, 67  
   - setting, 72  
 Spoke, 15  
 Stem,  
   - care, 64  
   - check 34, 67  
   - cleaning, 62  
   position 14  
 Suspension fork,  
   - cleaning, 61  
 System message, 26, 39
- T**  
 Total, 25  
 Trailer, 47  
 Transportation, 29  
 Transporting, see Transportation  
 Trip, 25  
 Type number, 8  
 Tyre rim,  
   - check 65

## Tyres, 15

- check 65
- check tyre pressure 65
- checking, 65

**U**

## USB port, 53

- check 67

**V**

## Valve, 15

- Dunlop valve, 15
- Presta valve, 15
- Schrader valve, 15

**W**

## Weight,

- shipping weight, 29
- Weight, 29
- permitted total weight, 8

## Wheel,

- cleaning, 62
- installing 33
- maintaining, 65

Winter break, see Break in operation